



Featherlite®

CONTEMPORARY
WORKSPACES CATALOGUE

VERSION: 01

Change is the only constant

However, we are here to talk about the beginning of an evolution. An evolution of work culture driven by a sense of comfort and efficiency. In the midst of chaos and distractions. It is time to feel at home, at work.

INDEX

About us	04
Design Thinking	08
Design Space	12
Genesis	22
Sofas	50
Lounge Chairs	92
High Chairs & Tables	106
Cafe Chairs	124
Tables	140
Nomad	168
Benches	176
Pouffes & Saddle	184
Laptop Tables	188
Tetris	192
Power Tower	198
Screens	200
Finishes	206

Who we are

Incorporated in 1965 Featherlite is one of the leading furniture manufacturing organization in India today, providing complete office furniture solutions for all segments of the market through its strong base of direct and franchisee offices present across 62 locations in India.

Featherlite Core expertise lies in manufacturing and marketing extremely innovative, cost effective and customized office furniture such as modular work stations, chairs, partitions, desks, conference tables, educational, laboratory, retail furnitur, soft seating and fixtures.

	over 7 million Chairs installed	
over 60 million sqft of office space fitted across India		over 25,000 corporate customers across India
	over 1.2 million Workstations installed	over 4.25 lakh sqft of factory space

Global Standards & Certifications

Featherlite is a member of BIFMA and is one of the leading Indian brands offering environmentally sustainable products as per ANSI/BIFMA e3-2014 standards. BIFMA compliance gives manufacturers, suppliers, architects, designers and government agencies a benchmark for production of sustainable office / institutional furniture and seating products. This mark establishes performance criteria that address environmental, economic and social aspects throughout the supply chain.

Our commitment is towards creating high quality & environmentally sustainable products



Green Guard Gold certification from UL Environment indicates that material process or finished product meets extremely rigorous standards for low emission of volatile organic compounds (VOCs)

100% Solar

Featherlite, besides being a leading Furniture Manufacturer in India is also a responsible Corporate Citizen. The Company is one of the first manufacturing unit in the state of Karnataka to not only sign an MOU with the State Government but also to implement and generate 1 MW Solar Rooftop Photovoltaic system (SRTPV) on an industrial building.

The "State of the Art" manufacturing unit located at Hejjala, 20km from Bangalore has a rooftop area of 1 Lakh sq. ft. The Company has utilized every available roof space including canteen, two wheeler stand, car parking roof and canopies besides the main manufacturing unit in order to maximize the power generation & generates over 1MW of Solar Power.

A total number of 3,000 solar panels each generating 320Wp of power per day and 16 string invertors support the power generation and transmission to Power Receiving Yard. The system has been integrated with state power supply board and surplus power generated is fed into the grid. The system will produce 1.5 million units per annum of which 0.5 million units will be fed into the grid lighting scores of house holds. This major initiative by the company has reaffirmed Group's commitment to minimizing environment degradation by reducing Carbon Footprint and helping the Government to achieve "Electricity for All" by 2020 goal set by the Prime Minister.



Major Clients



and thousands more

Design Thinking

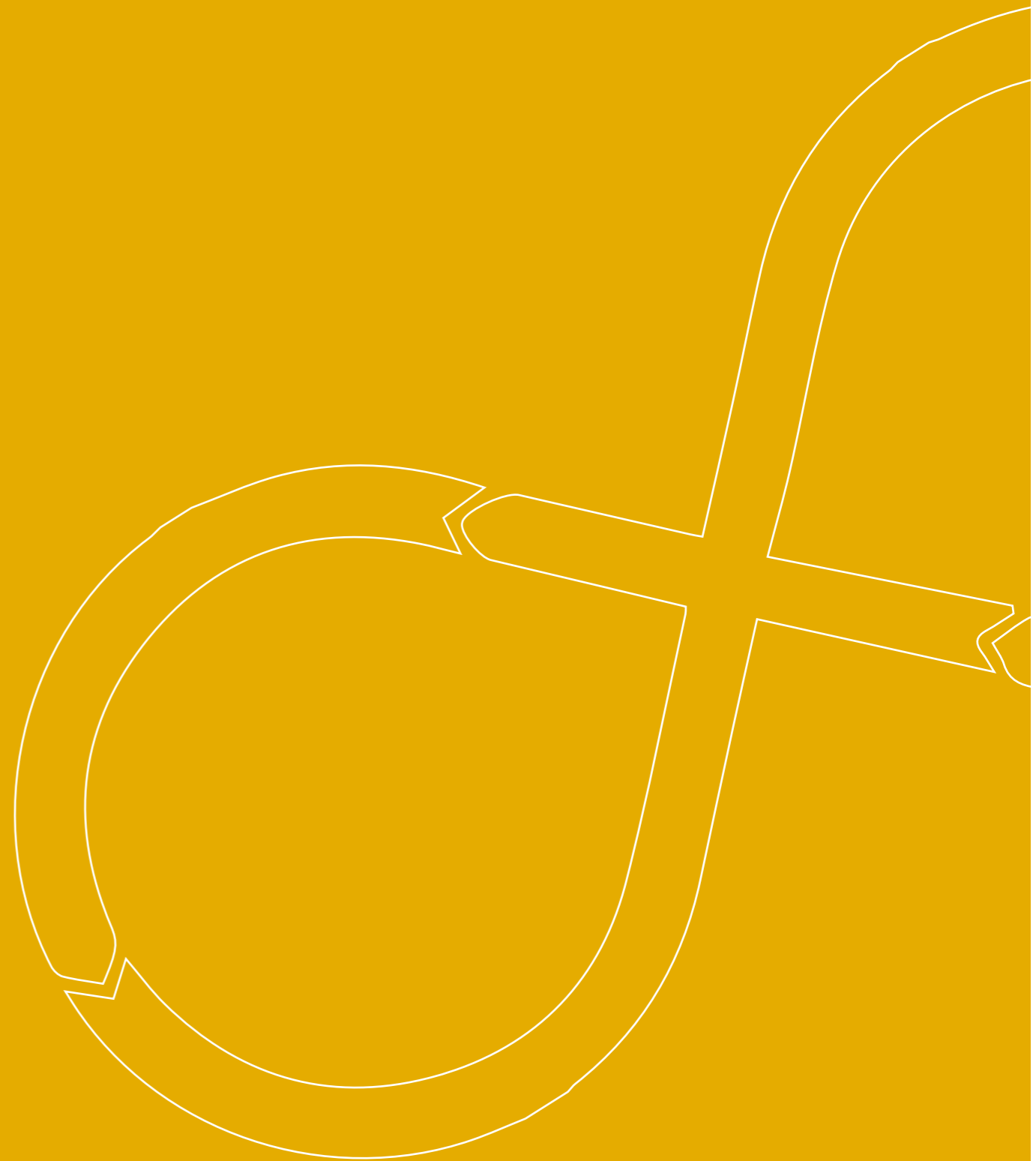
Design thinking is a process for solving problems by prioritizing the consumer's needs above all else.

It relies on observing, with empathy, how people interact with their environments, and employs an iterative, hands-on approach to creating innovative solutions.

Design thinking is "human-centered," which means that it uses evidence of how consumers (humans) actually engage with a product or service, rather than how someone else or an organization thinks they will engage with it.

This is the "iterative" part of design thinking. It favors moving quickly to get prototypes out to test, rather than endless research or rumination.

In contrast to traditional problem-solving, which is a linear process of identifying a problem and then brainstorming solutions, design thinking only works if it is iterative.





Empathize

Understanding People

In this first stage, the designer observes consumers to gain a deeper understanding of how they interact with or are affected by a product or issue. The observations must happen with empathy, which means withholding judgment and not imparting preconceived notions of what the consumer needs. Observing with empathy is powerful because it can uncover issues the consumer didn't even know they had or that they could not themselves verbalize. From this point, it's easier to understand the human need for which you are designing.



Prototype

Creation & Experimentation

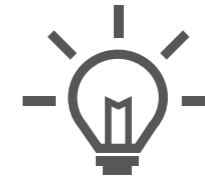
This is the stage that turns ideas into an actual solution. Prototypes are not meant to be perfect. The point of a prototype is to come out quickly with a concrete version of the idea to see how it is accepted by consumers. Examples of prototypes include a landing page to test consumer desire for a product or a video that demonstrates streamlined logistic processes.



Define

Figuring out the problem

In this second stage, you gather your observations from the first stage to define the problem you're trying to solve. Think about the difficulties your consumers are brushing up against, what they repeatedly struggle with, and what you've gleaned from how they're affected by the issue. Once you synthesize your findings, you are able to define the problem they face.



Ideate

Generating Your Ideas

The next step is to brainstorm ideas about how to solve the problem you've identified. These ideation sessions could be in a group, where your team gathers in an office space that encourages creativity and collaboration, an innovation lab, or can be done solo. The important part is to generate a bunch of different ideas. At the end of this process, you'll come up with a few ideas with which to move forward.



Test

Redefining the Product

Once you give a prototyped solution to consumers, you must observe how they interact with it. This testing stage is the one in which you collect feedback on your work.

The design-thinking process is an iterative, rather than linear, one. At the end of the fifth stage, you'll likely have to go back to one or several of the other stages. Perhaps the testing has shown you need to develop another prototype, for which you'd return to the fourth stage. Or perhaps it's shown that you've misdefined the consumer's needs. If so, you would have to return to an earlier stage of the process.

Space Ideas

At Featherlite, we convert open empty spaces into productive workspaces.

Through our products, we create areas which encourage collaboration and communication amongst teams, as well as focus and creativity when working alone.

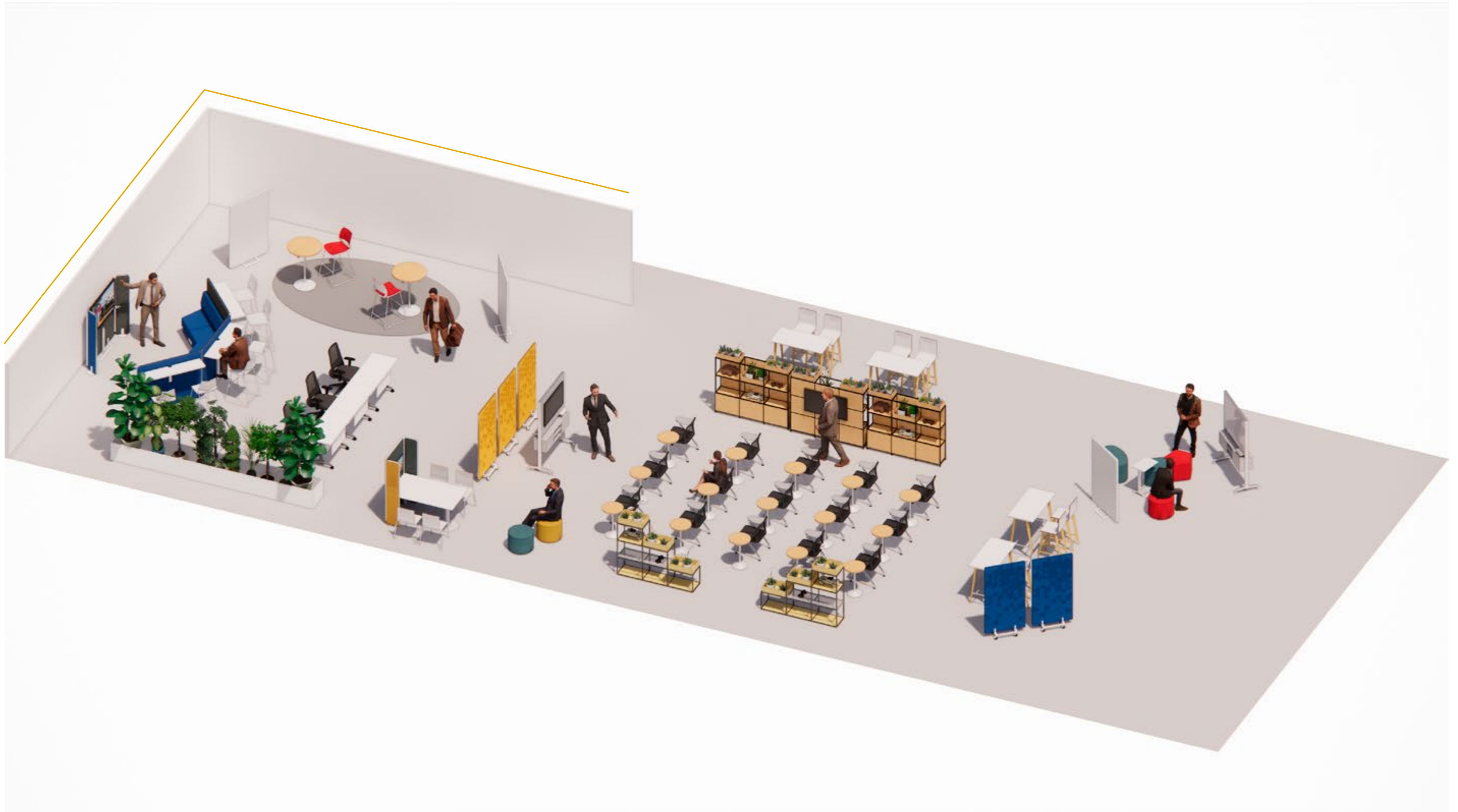
We ensure you get maximum efficiency from your available office space.



Collaboration Space



Learning Space



Personal Space



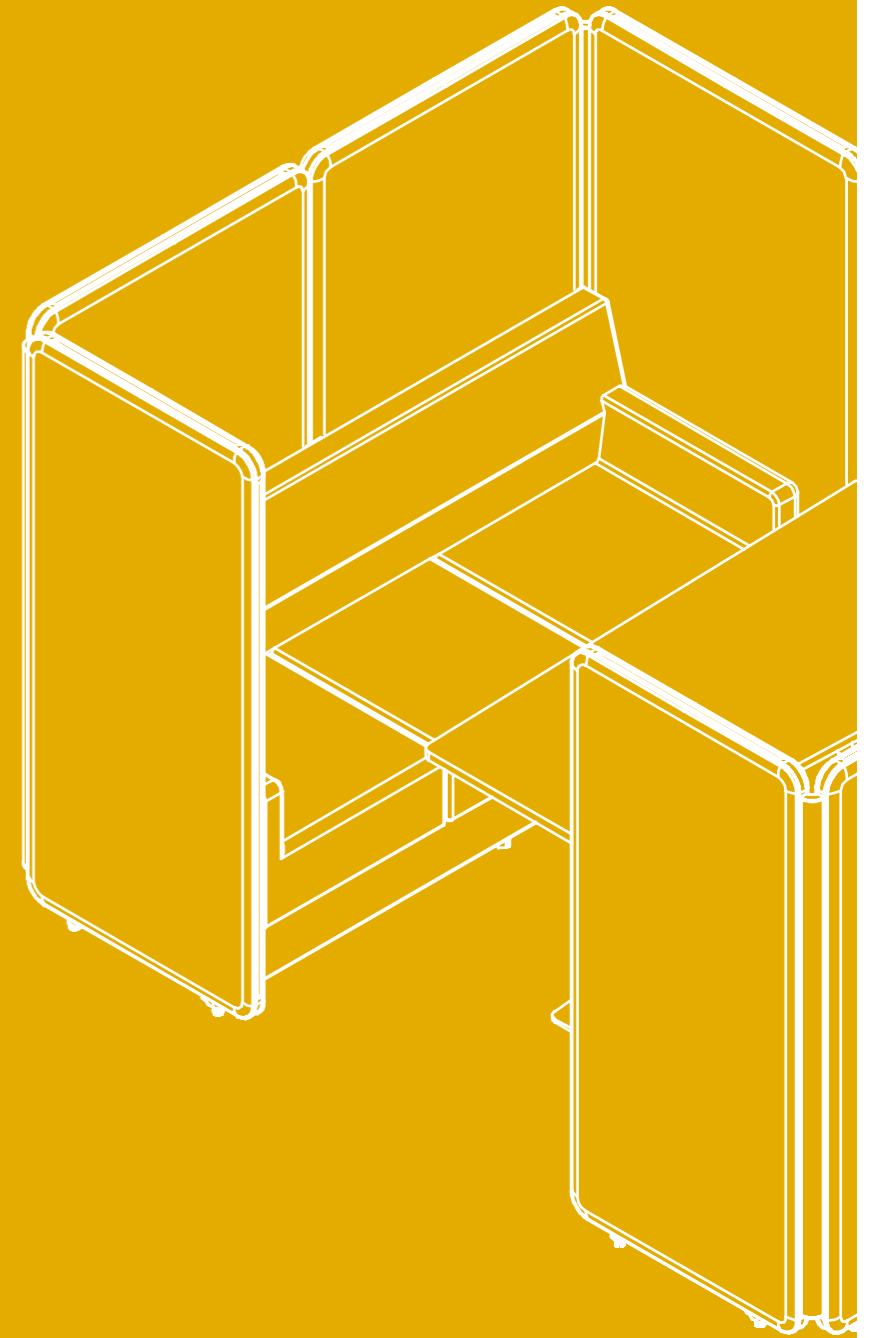
Social Space



Genesis

Genesis is a gateway to the elements of productivity. It is the convergence of privacy, focus and collaboration. Intimate yet open, this space respects individuality while strengthening team work. The Genesis design approach is one of duality, a demonstration of harmony between key standards - body and space, straightforward and inconspicuous, relentless yet delicate, cozy yet open.

We've chosen the materials used to make Genesis with extraordinary consideration. Subsequently, the peaceful structure reflects both the effortless and power contained within our idea.



01

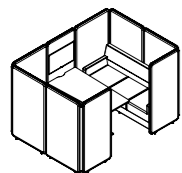
POD

The Genesis POD creates a bohemian environment and a casual perception of a work environment while catalysing employee efficiency and productivity. It is a micro office that is less expensive than traditional offices, allowing more people to fit into a smaller space.

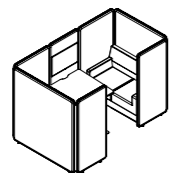
3 seater comfortable sofas on either side of a centre table are enclosed by specially designed sound absorbing acoustic walls. The POD is fitted with multiple charging points making it an ideal discussion or conference space that utilises light and ventilation from its surroundings.



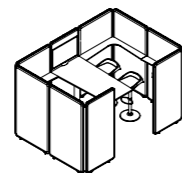
TECHNICAL DETAILS



3+3 Seater
L 2700 x W 1900 x H 1650 mm



2+2 Seater
L 2700 x W 1320 x H 1650 mm



With High Desk
L 2700 x W 1320 x H 1650 mm

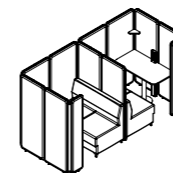
NOTE:

1. Aluminium extrusions comes with anodised finish.
2. Select one colour of fabric for inner and one colour for outer body panels.

WORK POD



TECHNICAL DETAILS



2+2 Seater
L 2980 x W 1320 x H 1650 mm

NOTE:

1. Aluminium extrusions comes with anodised finish.
2. Select one colour of fabric for inner and one colour for outer body panels.

POD

SEMI CLOSED

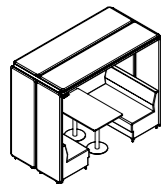


with Back Panel

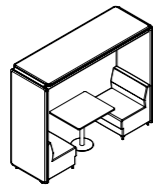


without Back Panel

TECHNICAL DETAILS



2+2 Seater
L 2700 x W 1350 x H 2150 mm



1+1 Seater
L 2700 x W 900 x H 2150 mm



Single Seater
L 1320 x W 900 x H 2150 mm

NOTE:

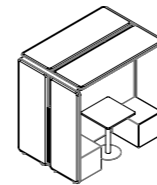
1. Aluminium extrusions comes with anodised finish.
2. Select one colour of fabric for inner and one colour for outer body panels.

SHARING POD

SEMI CLOSED



TECHNICAL DETAILS



4 Seater Sharing
L 1920 x W 1350 x H 1820 mm

NOTE:

1. Aluminium extrusions comes with anodised finish.
2. Select one colour of fabric for inner and one colour for outer body panels.



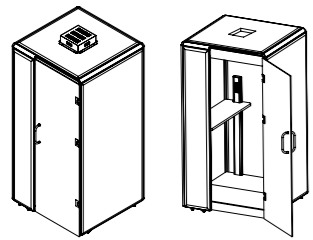
PHONE BOOTH

The Genesis Telephone Booth can turn any space into a private enclosure. It captures an insulated bubble of peace without the burden of difficult installation or renovation. Built in with plug and play electrical connections it allows office workers to stay within their work space and attend phone calls with the desired level of privacy.

With an extended table top, in built plug and play features and a backrest to lean on, the Booth is a one stop shop for those looking for private zones in an open air or indoor office environment.



TECHNICAL DETAILS



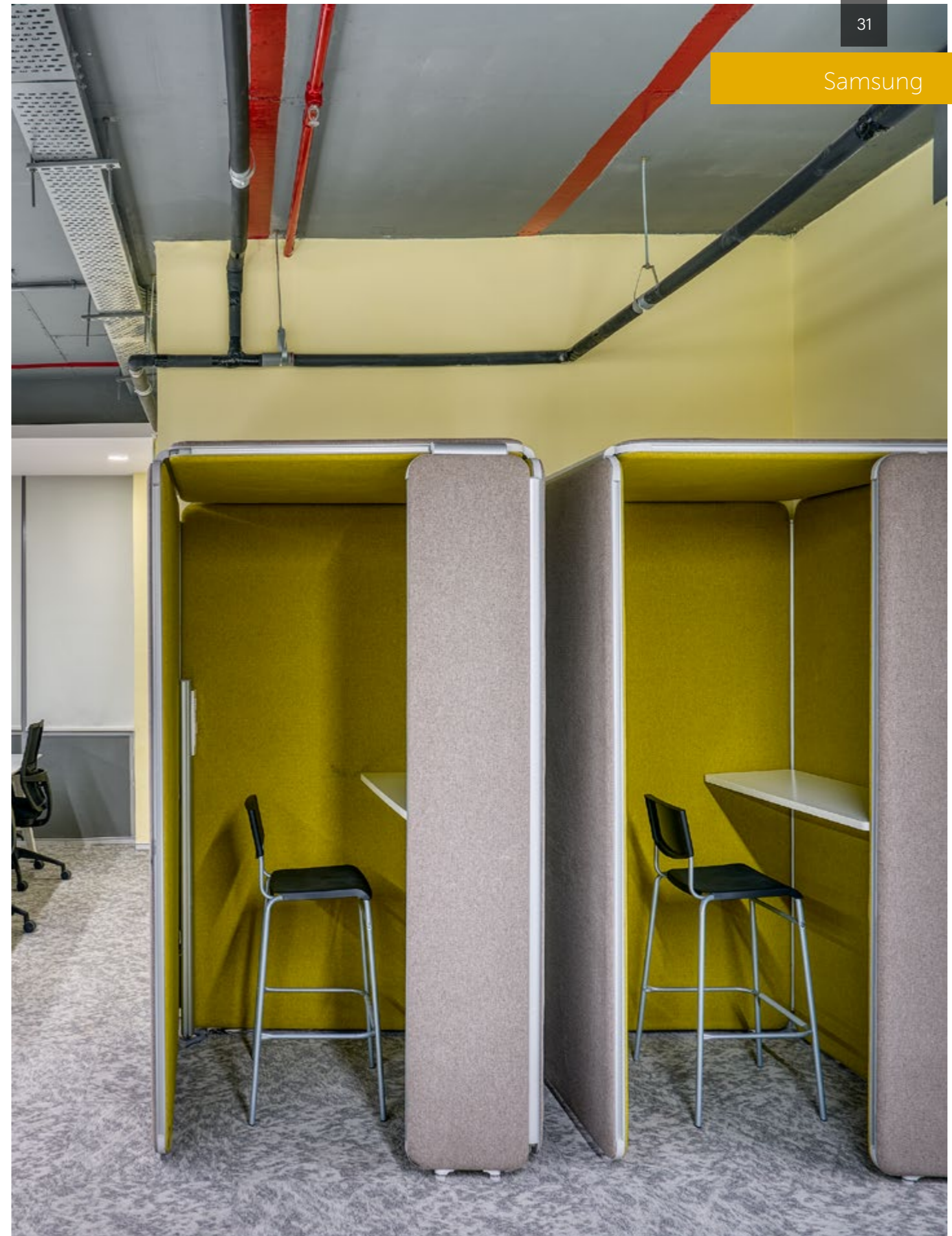
Booth
L 1200 x W 1200 x H 2100 mm

Shelf
L 1050 x W 350 x H 25 mm

NOTE:

1. Aluminium extrusions comes with anodised finish.
2. Select one colour of fabric for inner and one colour for outer body panels.

Samsung

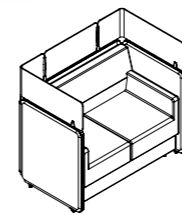


INTERACT

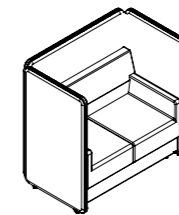
In organisations all across the world, coordinated effort has become the biggest catalyst for advancement and development. Genesis Interact is a perfect fit for an open workspace, with frosted acrylic screens that allow privacy and collaboration to go hand in hand creating an optimal and vibrant focus zone to help employees innovate faster, achieve better results and report higher job satisfaction.



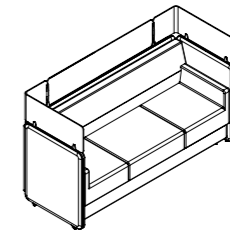
TECHNICAL DETAILS



2+2 Seater With Screen
L 1300 x W 800 x H 1200 mm



2+2 Seater Without Screen
L 1300 x W 800 x H 1200 mm



3+3 Seater With & Without Screen
L 1920 x W 800 x H 1200 mm

NOTE:

1. Aluminium extrusions comes with anodised finish.
2. Select one colour of fabric for inner and one colour for outer body panels.
3. Fabric colour of sofa is always same as of outer body of panels.

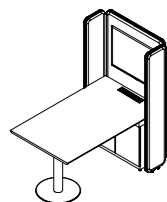
MEDIASCAPE

Find unlimited possibilities and forward-thinking design in Genesis Mediascape, which you can configure exactly the way you need it. It allows you to create a tailor made collaborative space in which people are free to circulate and interact in different settings.

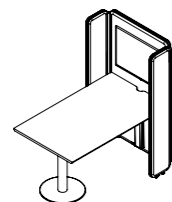
Genesis Mediascape incorporates innovation and furniture to bring individuals, space and data together for a greater collaborative work environment and more productivity.



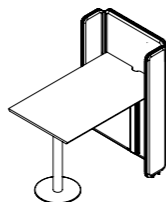
TECHNICAL DETAILS



Standard Height (With Storage)



Standard Height (Without Storage)



With High Desk (With & Without Storage)

Mediascape: L 1560 x W 1000 x H 1650 mm | Table: L 900 x W 1500 x H 750/1000 mm | Storage: L 750 x W 250 x H 725/975 mm

NOTE:

1. Aluminium extrusions comes with anodised finish.
2. Select one colour of fabric for inner and one colour for outer body panels.

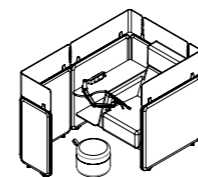
RECHARGE

Genesis Recharge is a private workspace that is intended to be useful for your body and for your mind – giving spots to get away without moving ceaselessly. It is a great fit for modern open space solutions, especially when task oriented work environments are combined with areas that are equipped for specific tasks.

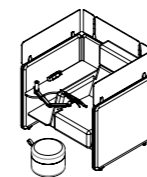
With the right amount of visual privacy, a built in power supply teamed with a support platform for notebooks & laptops, the Genesis Recharge meets th employee’s needs in a modern work space that makes you feel at home, at work.



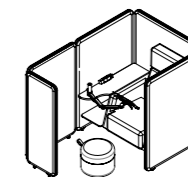
TECHNICAL DETAILS



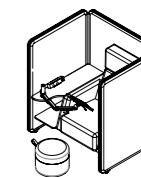
With Return Panel (With Screen)
L 1200 x W 1800 x H 1200 mm



Without Return Panel (With Screen)
L 1200 x W 950 x H 1200 mm



With Return Panel (Without Screen)
L 1200 x W 1800 x H 1200 mm



Without Return Panel (Without Screen)
L 1200 x W 950 x H 1200 mm

NOTE:

1. Aluminium extrusions comes with anodised finish.
2. Select one colour of fabric for inner and one colour for outer body panels.
3. Fabric colour of sofa is always same as of outer body of panels.
4. Leg rest comes with dual colours selected for inner/outer panels.



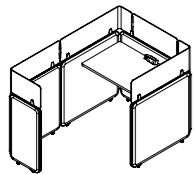
i-WORK

iWork is a high-performing private workstation planned explicitly for the in between spaces in corporate environments. As dedicated touchdown spaces for employees in open-plan workplaces iWork gives individuals moments of focus in high-traffic settings.

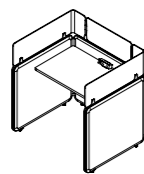
A room-in-room solution with the main features such as ventilation, visual privacy ease of assembly and the possibility to move the unit in a mounted state allows iWork to make an overall difference in employee performance and well being.



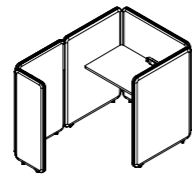
TECHNICAL DETAILS



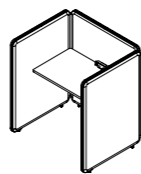
With Return Panel
(With Screen)
L 1200 x W 1800 x H 1200 mm



Without Return Panel
(With Screen)
L 1200 x W 950 x H 1200 mm



With Return Panel
(Without Screen)
L 1200 x W 1800 x H 1200 mm



Without Return Panel
(Without Screen)
L 1200 x W 950 x H 1200 mm

NOTE:

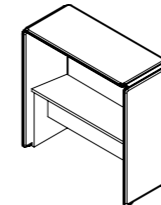
1. Aluminium extrusions comes with anodised finish.
2. Select one colour of fabric for inner and one colour for outer body panels.

PORTAL

Today's workers must be creative problem-solvers. The Portal privacy pod meets workers' diverse needs for collaboration, privacy, focus and regeneration in a whole new way. With creativity front and center in the work people are doing today, spaces like Portal that optimize the creative output of teams and individuals are increasingly important. The creative process isn't limited to large group brainstorming and open plan collaboration – having access to spaces for focus work or smaller, uninterrupted conversations is just as crucial to unleashing a team's full creative potential.



TECHNICAL DETAILS



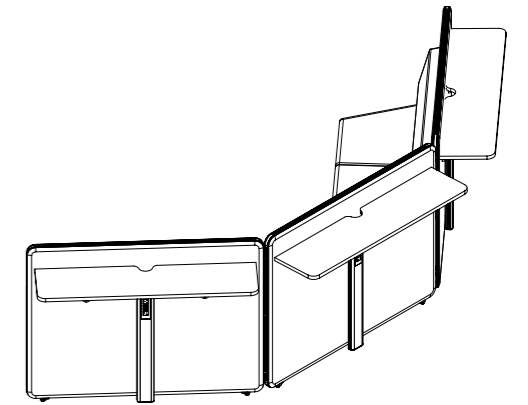
Pod: L 2130 x W 900 x H 2130 mm
Table: L 2010 x W 600 x H 1100 mm

NOTE:

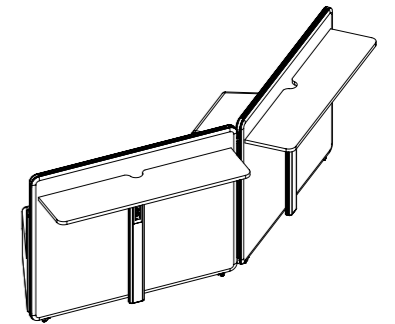
1. Aluminium extrusions comes with anodised finish.
2. Select one colour of fabric for inner and one colour for outer body panels.

ARENA

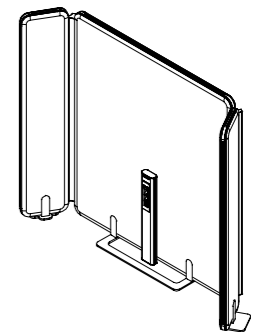
The Arena is a spectacle of ergonomic design and provides multi functionality. Employees have the option of using it not only for collaboration but also individual focused work. There are desk spaces fitted on to the back of the Arena which makes it an additional work area. With electrical supplies for charging devices and Ethernet ports for internet connectivity, the Arena is a complete office furniture design that can help catalyze collaboration and grow employee productivity.



6+6 SEATER ARENA



4+4 SEATER ARENA



MEDIA UNIT



TECHNICAL DETAILS

6+6 Seater Arena	L 4500 x W 1750 x H 1200 mm
4+4 Seater Arena	L 2965 x W 1390 x H 1200 mm
Media Unit Dimensions	L 1860 x W 460 x H 1500 mm

NOTE:

1. Aluminium extrusions comes with anodised finish.
2. Select one colour of fabric for inner and one colour for outer body panels.



Featherlite Evoma



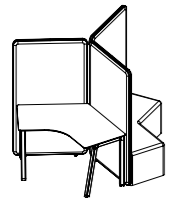
MULTIPLY

Multiply is based on the concept of functional geometry. The trifecta shape allows you to multiply space utilisation by having 3 exposed sides, each with its own purpose and sheltered from visual and sonic disturbances on all sides.

An average employee has a third less space in their office than they did a decade ago. Genesis Multiply lets you fit more people into smaller task specific spaces.



TECHNICAL DETAILS



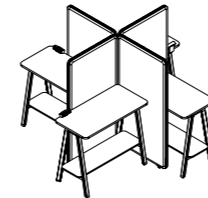
L 1900 x W 1900 x H 1650 mm

NOTE:
1. Aluminium extrusions comes with anodised finish.

STUDY

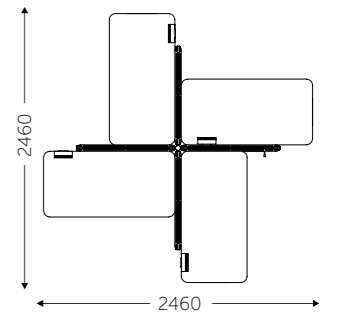


TECHNICAL DETAILS



Screen (LxH) : 900 x 1650 mm | Table (LxWxH) : 1200 x 600 x 1050 mm

NOTE:
1. Aluminium extrusions comes with anodised finish.



REFLECT

Designed for today's inclusive, flexible workplace, Genesis Reflect was born out of the realisation that teamwork and collaborative events are intrinsic to the success of the world's top companies.

With a straight forward mirror image design, Reflect serves as a new kind of seating for casual work environments, where employees can relax and rejuvenate, kill time between appointments, and above all feel at ease.



TECHNICAL DETAILS

Reflect Dimensions (LxWxH)	2000 x 1360 x 900 mm
Table Top Dimensions	650 x 550 x 40 mm

NOTE:

1. Aluminium extrusions comes with anodised finish.
2. Select one colour of fabric for inner and one colour for outer body panels.



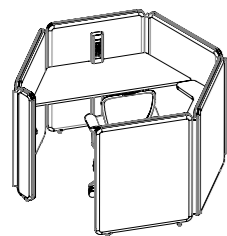
HONEY COMB

Honey Comb is your perfect noise barrier, acoustically enhanced to separate you from the hubbub of the workplace. Honeycomb is designed to create a sense of privacy in one's own nest, while still being in close contact with teammates around.

With numerous configurations available and a degree of tech-savviness, Honey Comb supports not only your work style but also varying IT needs. Honey Comb's wire accesses, data connectivity, and acoustic properties make it the ideal work retreat.



TECHNICAL DETAILS



L 1722 x W 1722 x H 1200 mm



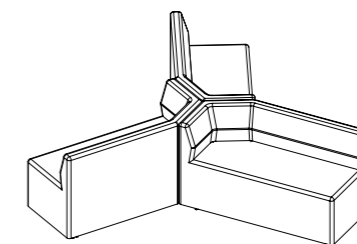
NOTE:

1. Aluminium extrusions comes with anodised finish.
2. Select one colour of fabric for inner and one colour for outer body panels.

REFLEX

Perfectly suited for social and relaxation spaces, the Reflex sofas are a stylish design choice for the centre of any space. With the ability to hold up to 2 people on each sofa, Reflex creates a sense of privacy while also creating a sense of togetherness for the occupants.

With up to three different colour combinations, Reflex adds a touch of vibrancy and brightness to any office space.

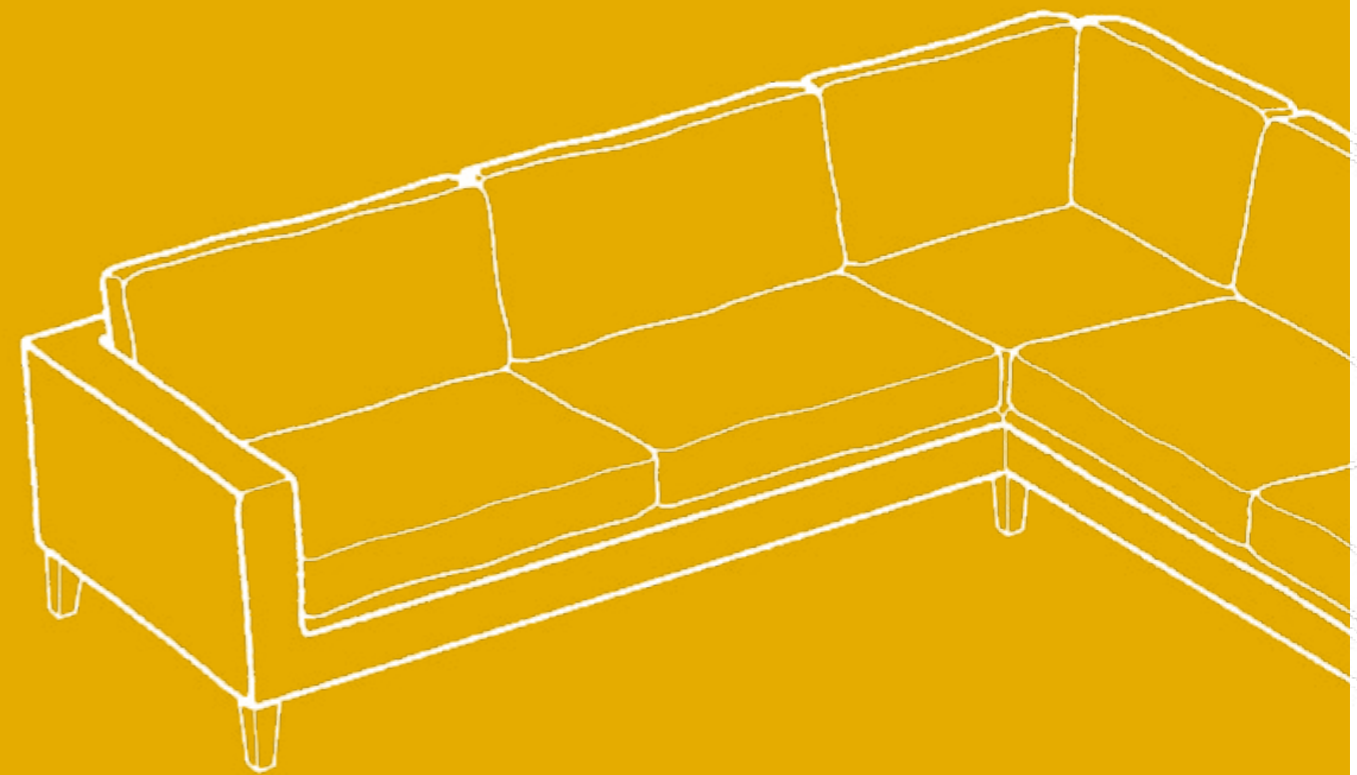


L 2800 x W 2350 x H 860 mm

Sofas

Sofas are one of the many first impressions for customers and clients when visiting a space. Contemporary Sofa Designs reflect the character of the company and the people within the enterprise.

Featherlite Sofas boast comfortable and enveloping design features with a light structure and a contemporary padded seat that ensures to be suitable in both modern and traditional design environments.

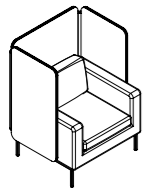


02

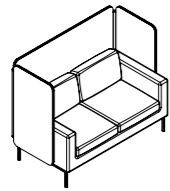
OMEGA 1



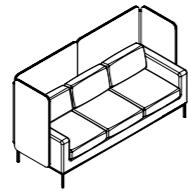
TECHNICAL DETAILS



Single Seater
L 900 x D 820 x H 1200 mm



Two Seater
L 1500 x D 820 x H 1200 mm



Three Seater
L 2100 x D 820 x H 1200 mm

NOTE:

1. Aluminium extrusions comes with anodised finish.

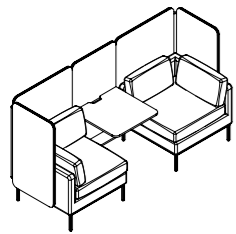


OMEGA 2



With work table and power management

TECHNICAL DETAILS



L 2275 x D 820 x H 1200

NOTE:

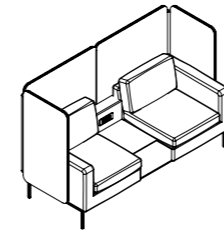
1. Aluminium extrusions comes with anodised finish.

OMEGA 3



With centre table and power management

TECHNICAL DETAILS



L 1900 x D 820 x H 1200 mm

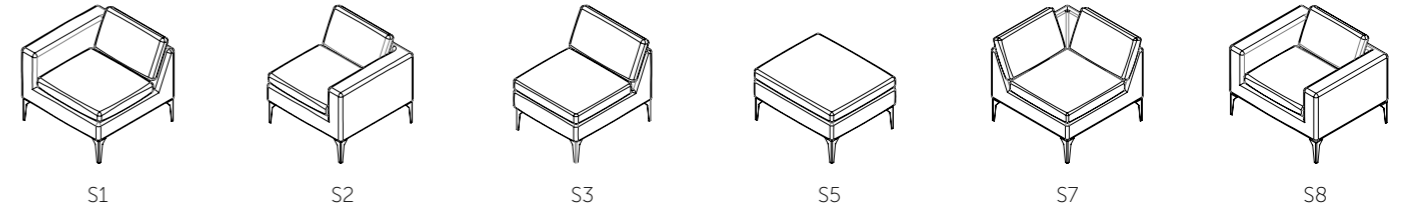
NOTE:

1. Aluminium extrusions comes with anodised finish.

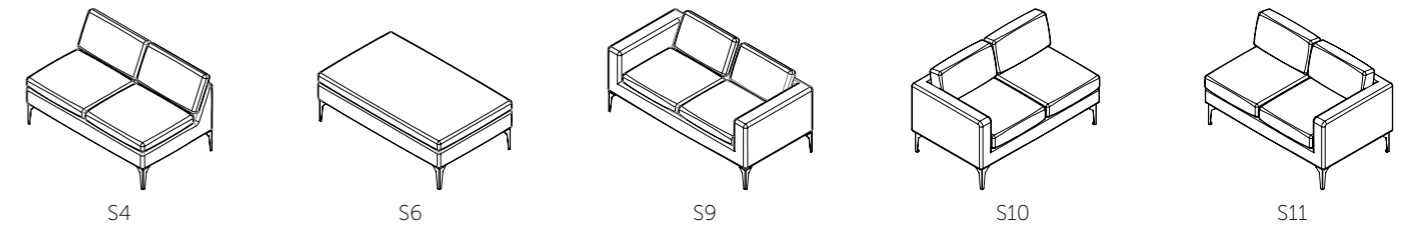
S SERIES



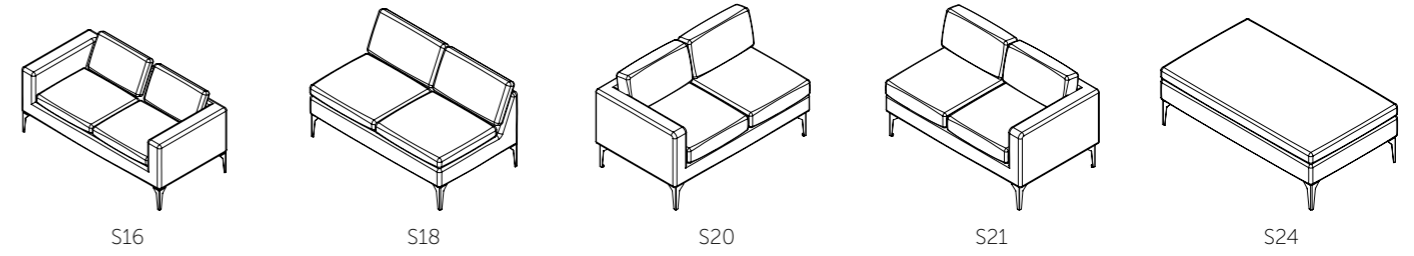
Single Seater



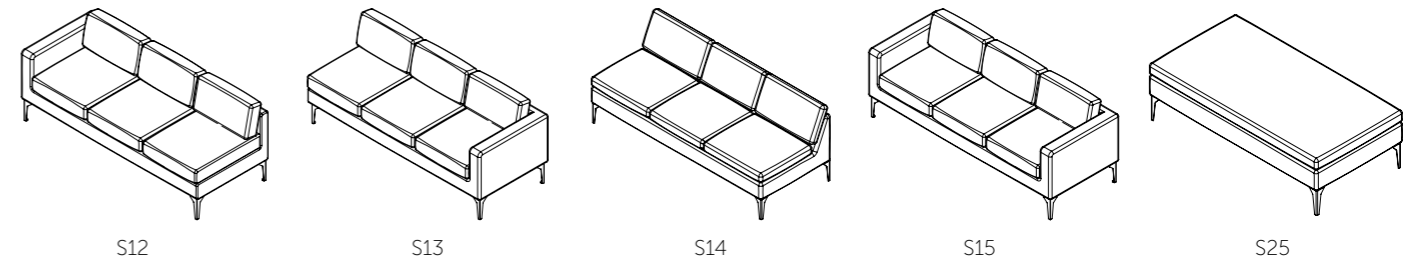
Two Seater



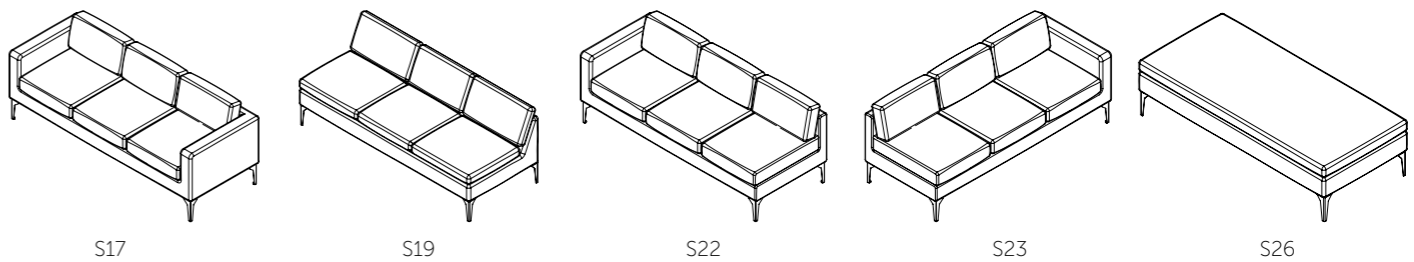
Two & Half Seater



Three Seater



Three & Half Seater



TECHNICAL DETAILS

Metal Powder Coated

S1: L 725 x D 790 x H 790
 S2: L 725 x D 790 x H 790
 S3: L 600 x D 790 x H 790
 S4: L 1200 x D 790 x H 790
 S5: L 600 x D 550 x H 450
 S6: L 1200 x D 550 x H 450
 S7: L 790 x D 790 x H 790

S8: L 850 x D 790 x H 790
 S9: L 1450 x D 790 x H 790
 S10: L 1325 x D 790 x H 790
 S11: L 1325 x D 790 x H 790
 S12: L 1925 x D 790 x H 790
 S13: L 1925 x D 790 x H 790
 S14: L 1800 x D 790 x H 790

S15: L 2050 x D 790 x H 790
 S16: L 1750 x D 790 x H 790
 S17: L 2350 x D 790 x H 790
 S18: L 1500 x D 790 x H 790
 S19: L 2100 x D 790 x H 790
 S20: L 1625 x D 790 x H 790

S21: L 1625 x D 790 x H 790
 S22: L 2225 x D 790 x H 790
 S23: L 2225 x D 790 x H 790
 S24: L 1500 x D 550 x H 450
 S25: L 1800 x D 550 x H 450
 S26: L 2100 x D 550 x H 450

S SERIES





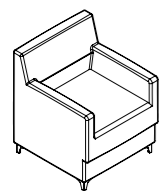
GENESIS SOFA WITH ARMS



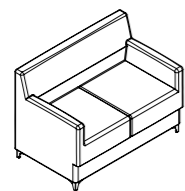
GENESIS SOFA WITHOUT ARMS



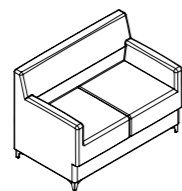
TECHNICAL DETAILS



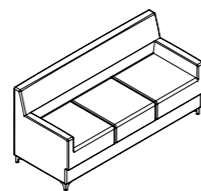
Single Seater
L 700 x D 725 x H 860



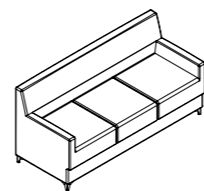
Two Seater
L 1200 x D 725 x H 860



Two & Half Seater
L 1500 x D 725 x H 860



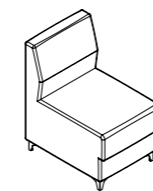
Three Seater
L 1800 x D 725 x H 860



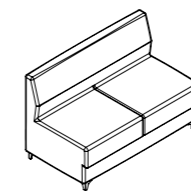
Three & Half Seater
L 2100 x D 725 x H 860

TECHNICAL DETAILS

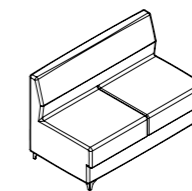
Metal Powder Coated



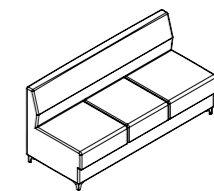
Single Seater
L 530 x D 725 x H 860



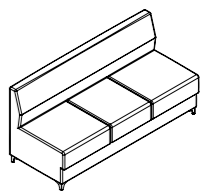
Two Seater
L 1060 x D 725 x H 860



Two & Half Seater
L 1360 x D 725 x H 860



Three Seater
L 1590 x D 725 x H 860



Three & Half Seater
L 1890 x D 725 x H 860

M SERIES

METAL POWDER COATED LEGS



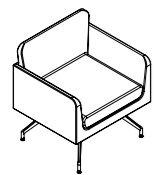
W SERIES

SOLID WOOD LEGS

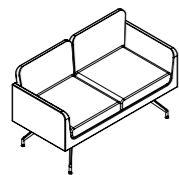


TECHNICAL DETAILS

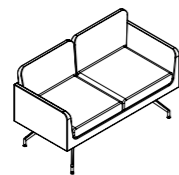
Metal Powder Coated Legs



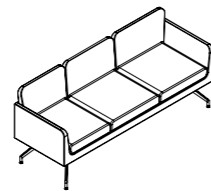
Single Seater
L 700 x D 665 x H 780



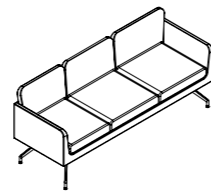
Two Seater
L 1200 x D 665 x H 780



Two & Half Seater
L 1500 x D 665 x H 780



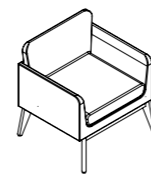
Three Seater
L 1800 x D 665 x H 780



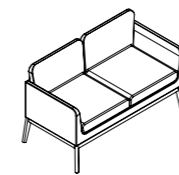
Three & Half Seater
L 2100 x D 665 x H 780

TECHNICAL DETAILS

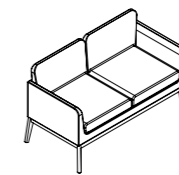
Solid Wood Legs



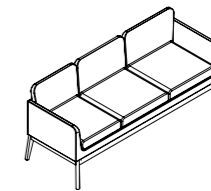
Single Seater
L 700 x D 665 x H 780



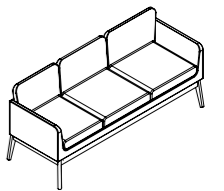
Two Seater
L 1200 x D 665 x H 780



Two & Half Seater
L 1500 x D 665 x H 780

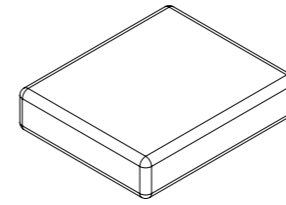


Three Seater
L 1800 x D 665 x H 780

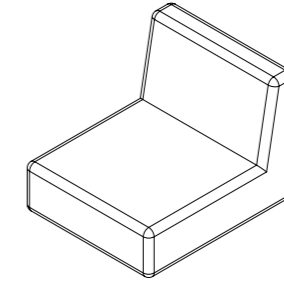


Three & Half Seater
L 2100 x D 665 x H 780

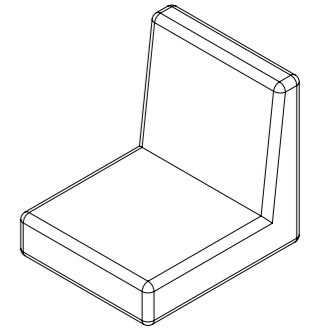
F SERIES



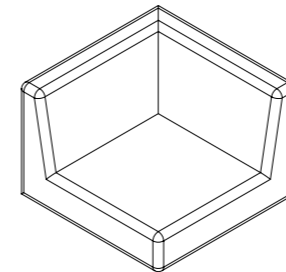
F1
L 600 x D 675 x H 150



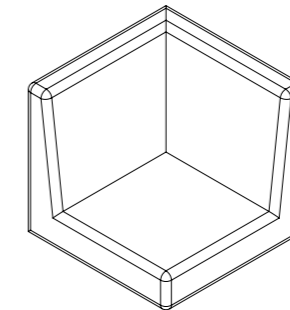
F2
L 600 x D 675 x H 450



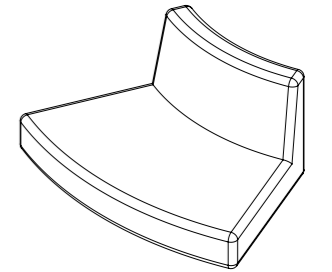
F3
L 600 x D 675 x H 600



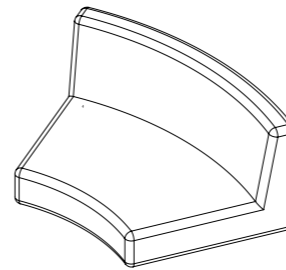
F4
L 675 x D 675 x H 450



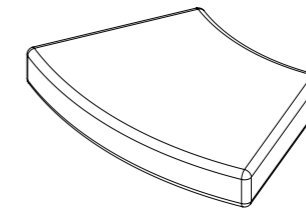
F5
L 675 x D 675 x H 600



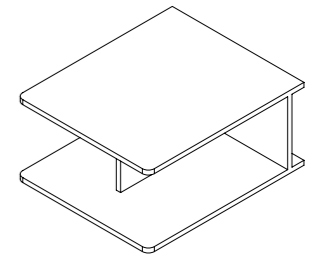
F6
L 1060 x D 675 x H 450



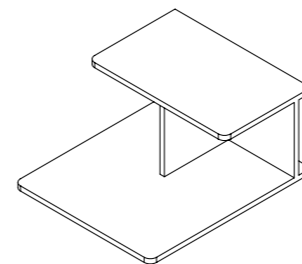
F7
L 1060 x D 675 x H 450



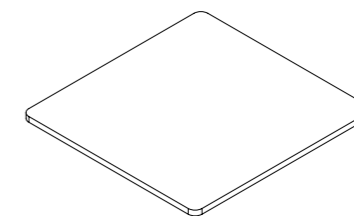
F8
L 1060 x D 675 x H 150



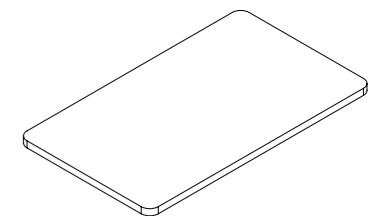
F9
L 600 x D 675 x H 300



F10
L 600 x D 675 x H 300



F11
L 600 x D 675 x 18mm Thickness



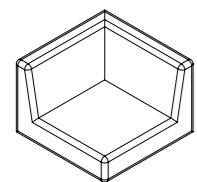
F12
L 300 x D 675 x 18mm Thickness

F SERIES



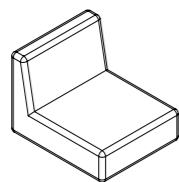
TECHNICAL DETAILS

Metal Powder Coated Legs



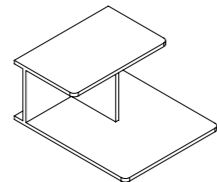
F4 (x1)
L 675 x D 675 x H 450

+



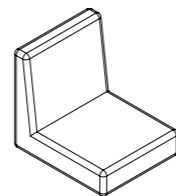
F2 (x2)
L 600 x D 675 x H 450

+



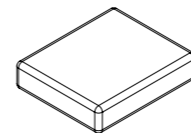
F10 (x1)
L 600 x D 675 x H 300

+



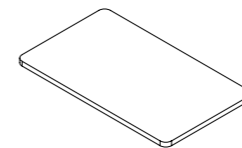
F3 (x2)
L 600 x D 675 x H 600

+



F1 (x1)
L 600 x D 675 x H 150

+



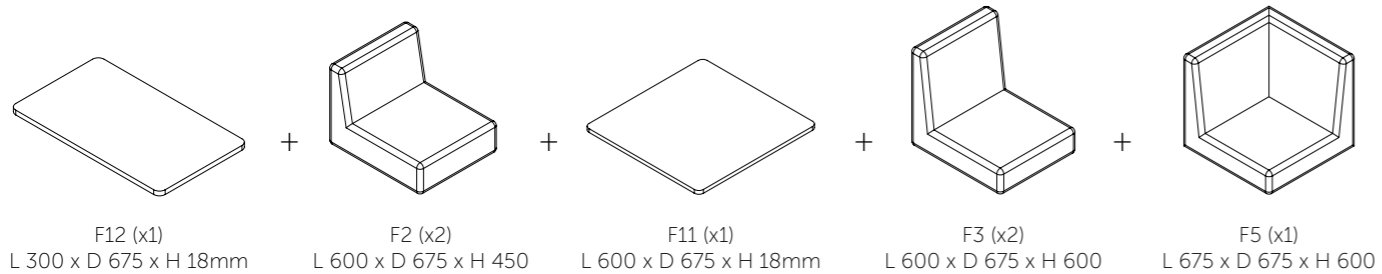
F12 (x1)
L 300 x D 675 x H 18mm Thickness

F SERIES



TECHNICAL DETAILS

Metal Powder Coated Legs

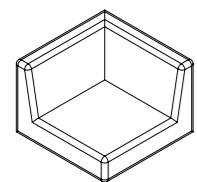


F SERIES

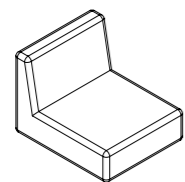


TECHNICAL DETAILS

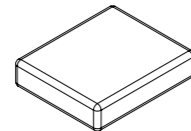
Metal Powder Coated Legs



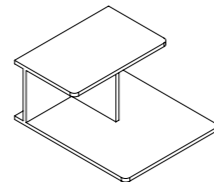
F4 (x4)
L 675 x D 675 x H 450



F2 (x8)
L 600 x D 675 x H 450



F1 (x1)
L 600 x D 675 x H 150

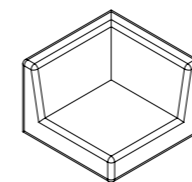


F10 (x1)
L 600 x D 675 x H 300

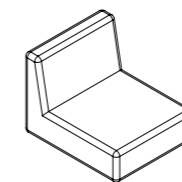


TECHNICAL DETAILS

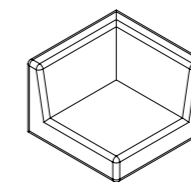
Metal Powder Coated Legs



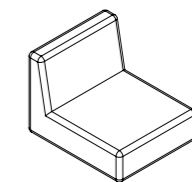
F4 (x2)
L 675 x D 675 x H 450



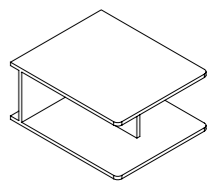
F2 (x2)
L 600 x D 675 x H 450



F4 (x4)
L 675 x D 675 x H 450



F2 (x6)
L 600 x D 675 x H 450



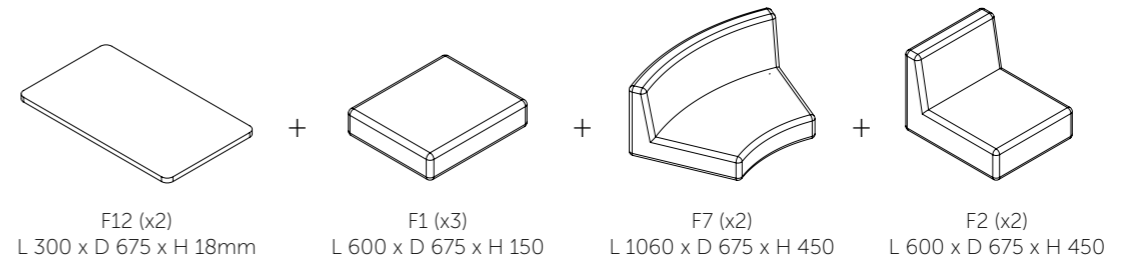
F9 (x2)
L 600 x D 675 x H 300

F SERIES



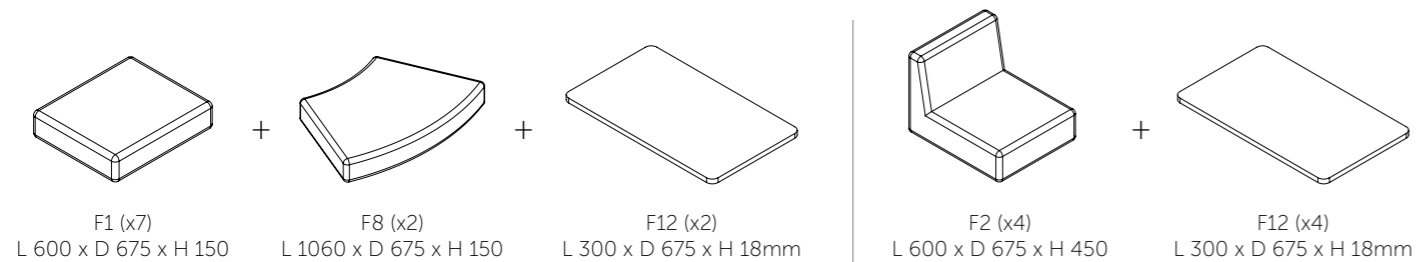
TECHNICAL DETAILS

Metal Powder Coated Legs



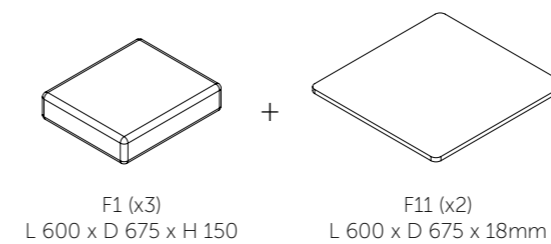
TECHNICAL DETAILS

Metal Powder Coated Legs



TECHNICAL DETAILS

Metal Powder Coated Legs

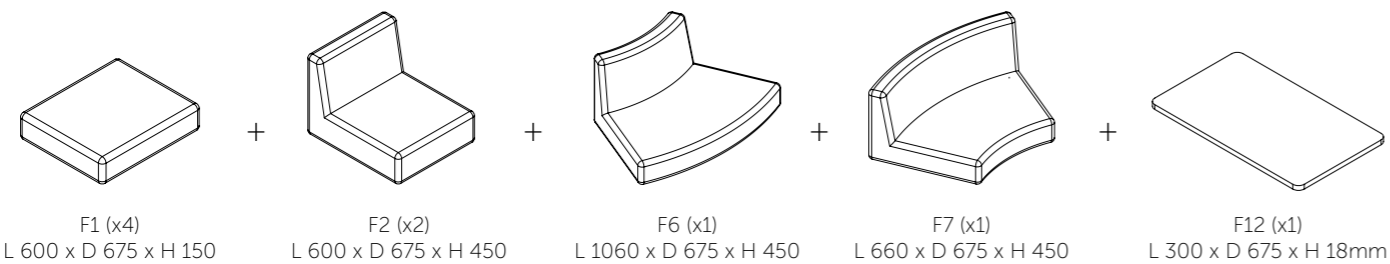


F SERIES



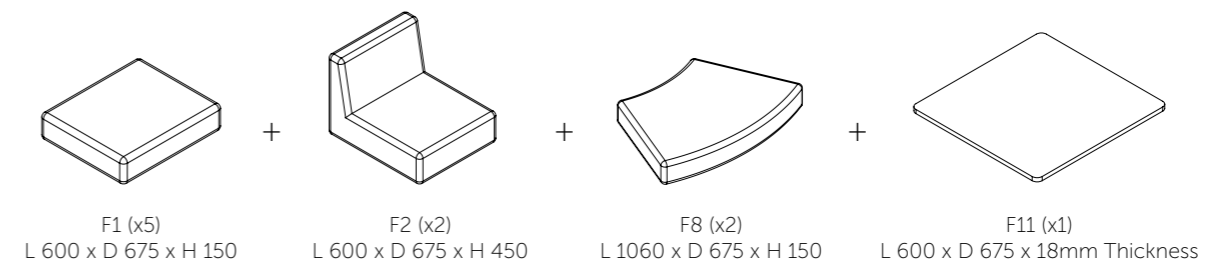
TECHNICAL DETAILS

Metal Powder Coated Legs



TECHNICAL DETAILS

Metal Powder Coated Legs

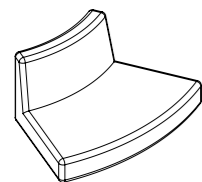


F SERIES

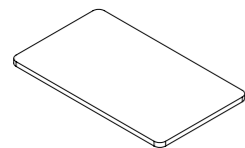


TECHNICAL DETAILS

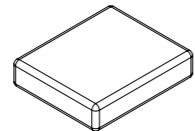
Metal Powder Coated Legs



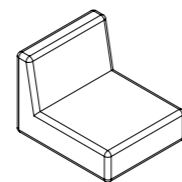
F6 (x8)
L 1060 x D 675 x H 450



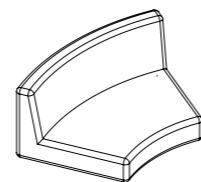
F12 (x2)
L 300 x D 675 x H 18mm



F1 (x2)
L 600 x D 675 x H 150



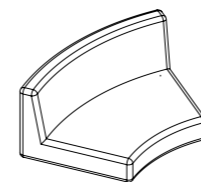
F2 (x4)
L 600 x D 675 x H 450



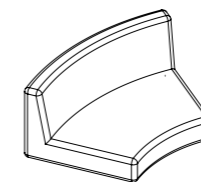
F7 (x4)
L 660 x D 675 x H 450

TECHNICAL DETAILS

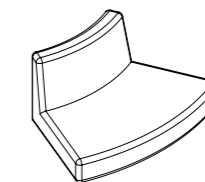
Metal Powder Coated Legs



F7 (x6)
L 660 x D 675 x H 450



F7 (x4)
L 660 x D 675 x H 450



F6 (x4)
L 1060 x D 675 x H 450

F SERIES



PEARL LEATHERETTE / FABRIC



1 Seater: 810 (L) x 720 (D) X 685 (H) | **2 Seater:** 1320 (L) x 720 (D) X 685 (H) | **3 Seater:** 1855 (L) x 720 (D) X 685 (H)
Legs: Steel & Chrome

CONVERSE LEATHERETTE / FABRIC



1 Seater: 890 (L) x 800 (D) X 820 (H) | **2 Seater:** 1390 (L) x 800 (D) X 820 (H) | **3 Seater:** 1930 (L) x 800 (D) X 820 (H)
Legs: Steel & Chrome

INTERACT LEATHERETTE / FABRIC



1 Seater: 770 (L) x 750 (D) X 740 (H) | **2 Seater:** 1280 (L) x 750 (D) X 740 (H) | **3 Seater:** 1830 (L) x 750 (D) X 740 (H)
Legs: Steel & Chrome

INDULGE LEATHERETTE / FABRIC



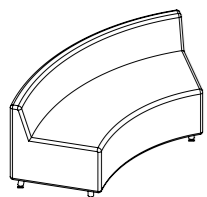
1 Seater: 770 (L) x 750 (D) X 740 (H) | **2 Seater:** 1280 (L) x 750 (D) X 740 (H) | **3 Seater:** 1830 (L) x 750 (D) X 740 (H)
Legs: Steel & Chrome

CONCAVE

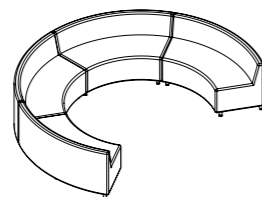


TECHNICAL DETAILS

Metal Powder Coated



Concave Single
Outer R 1650 / Inner R 1000 x D 650 x H 750 mm



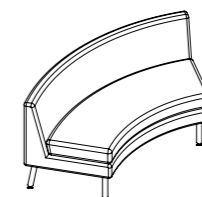
Semi Circle
Outer Dia 3300 / Inner Dia 2000 x D 650 x H 750 mm

CONCAVE 2P



TECHNICAL DETAILS

Metal Powder Coated



Concave 2P Single
Outer R 1650 / Inner R 1000 x D 650 x H 750 mm

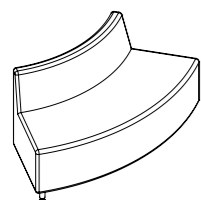


CONVEX

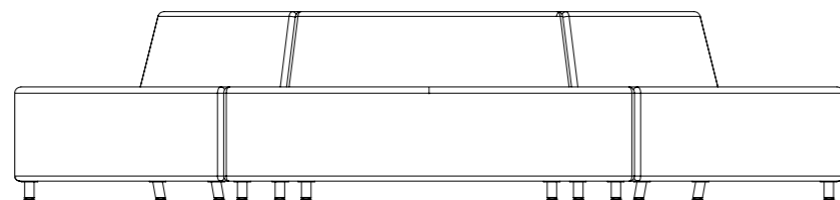


TECHNICAL DETAILS

Metal Powder Coated



Convex
Outer R 1650 / Inner R 1000 x D 650 x H 750 mm



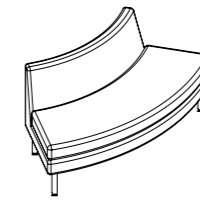
Circular
Outer Dia 3300 / Inner Dia 2000 x D 650 x H 750 mm

CONVEX 2P



TECHNICAL DETAILS

Metal Powder Coated



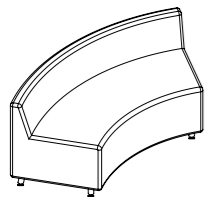
Convex 2P Single
Outer R 1650 / Inner R 1000 x D 650 x H 750 mm

S SHAPE

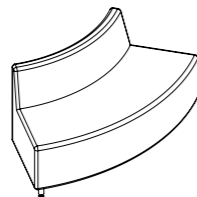


TECHNICAL DETAILS

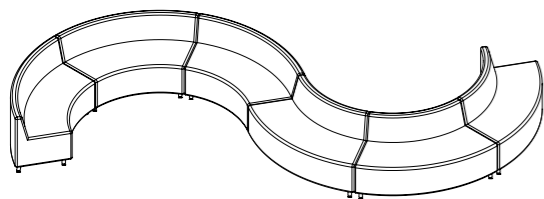
Metal Powder Coated



Concave
Outer R 1650 / Inner R 1000 x D 650 x H 750 mm



Convex
Outer R 1650 / Inner R 1000 x D 650 x H 750 mm



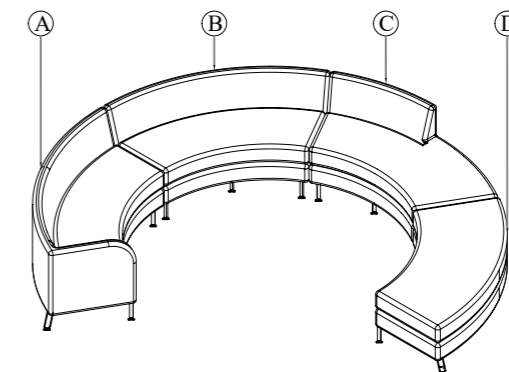
S Shape 6 Piece
L 5140 x D 4625 x H 750 m

SEMI CIRCULAR



TECHNICAL DETAILS

Metal Powder Coated



A: With back rest & Armrest | B: With Back rest | C: With half back rest | D: Without back rest

Single Sofa

Outer R 1650 / Inner R 1000 x D 650 x H 750 mm (with back rest) / W.O. back rest H 450 mm

Semi Circular Sofa

Outer Dia 3300 / Inner Dia 2000 x D 3170 x H 750 mm

Lounge Chairs

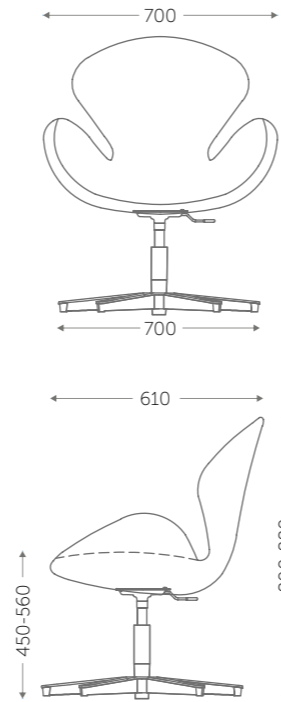
One of the most important aspects of running a business is creating a comfortable environment for customers.

Our office lounge chairs are created with the goal of comfort in mind. Whether it be for the waiting spaces, or even the lounge and meeting spaces, our soft seating keeps ergonomics and posture in mind, while maintaining a contemporary appeal by adding a burst of colour to your office space.

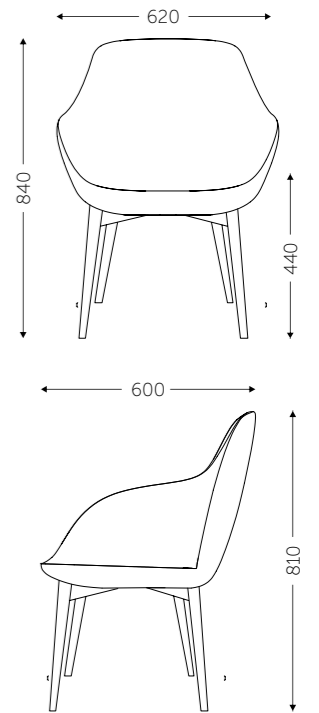


03

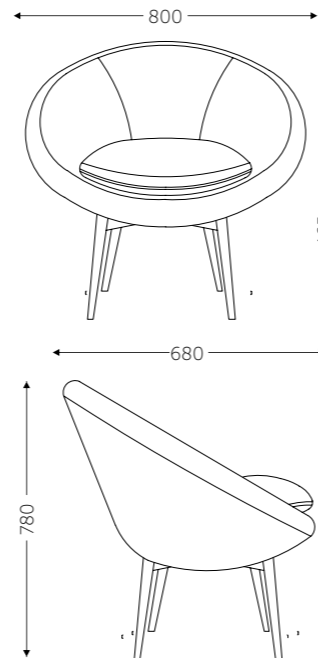
FLORA



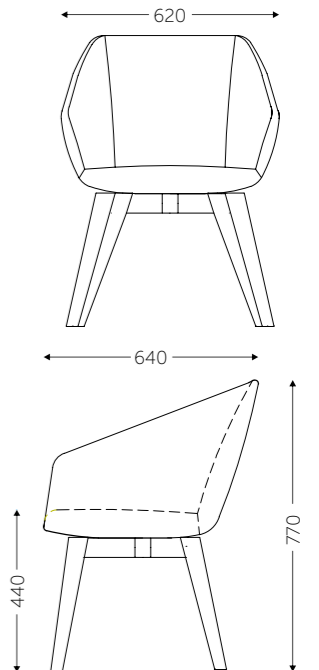
COSTA



ARCTIC



CLARA



Black Powder Coated



Silver Powder Coated



Alluminium



Solid Wood



Black Powder Coated



Silver Powder Coated

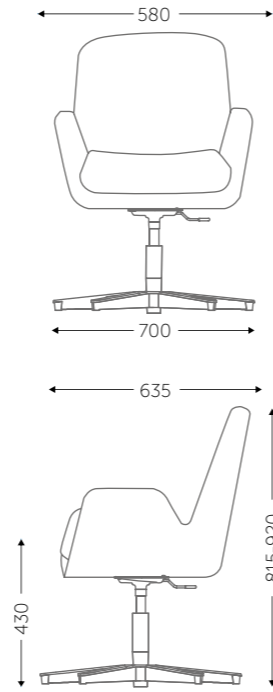


Alluminium

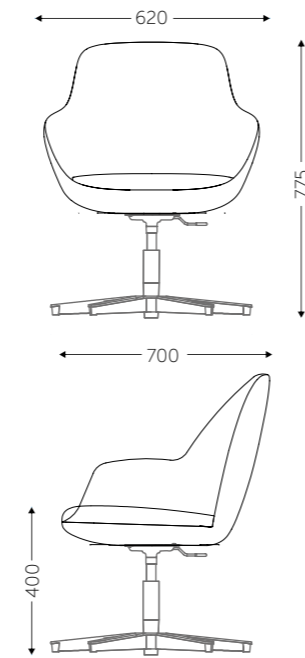


Solid Wood

NOVA



ELLA



Black Powder Coated



Silver Powder Coated

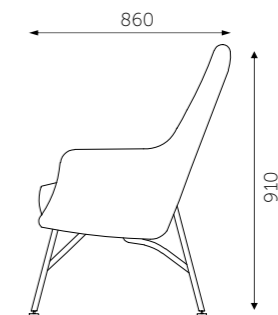
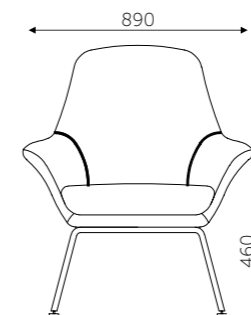


Alluminium



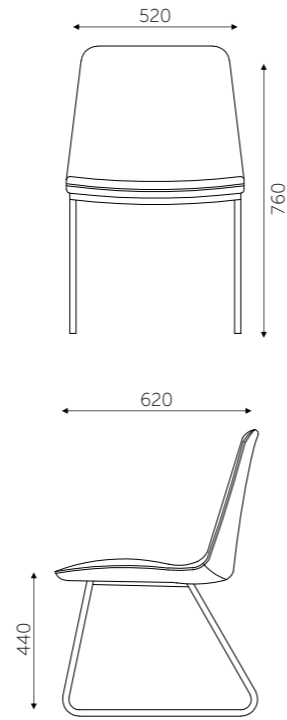
Solid Wood

OLIVIA



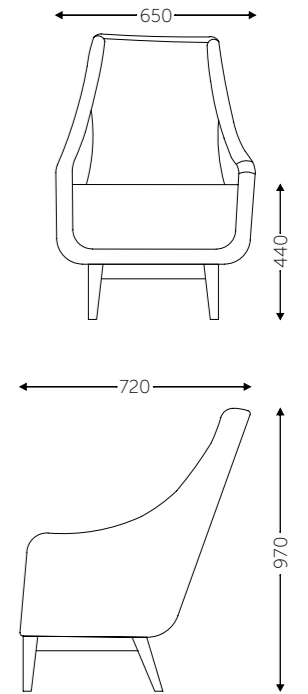
Metal Powder Coated

FREYA



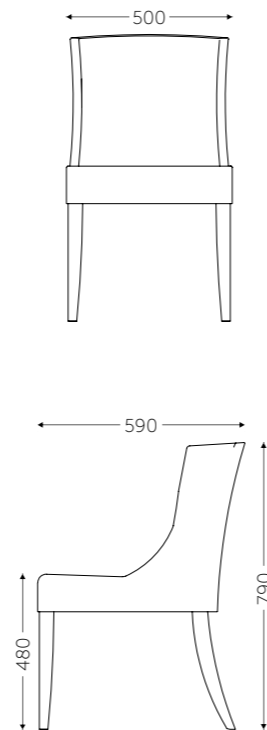
Metal Powder Coated Understructure

LUCA



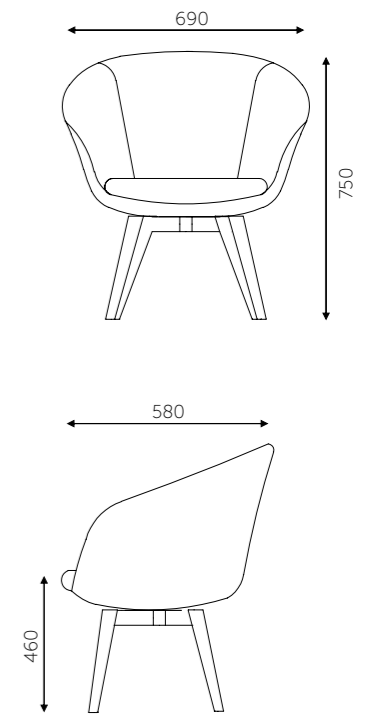
Solid Wood Legs

ATHENA



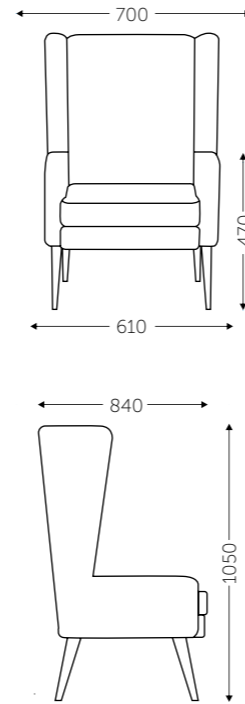
Solid Wood Legs

LUNA



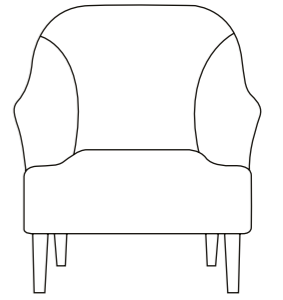
Solid Wood Legs

WING



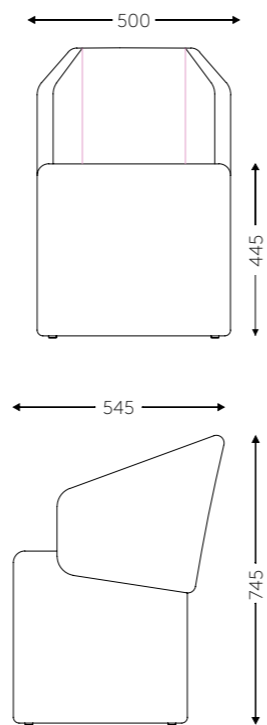
Metal Powder Coated Legs

AURORA

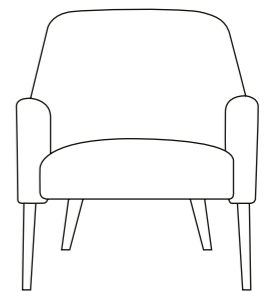


Solid Wood Legs

CORA



SIENNA



Metal Powder Coated Legs

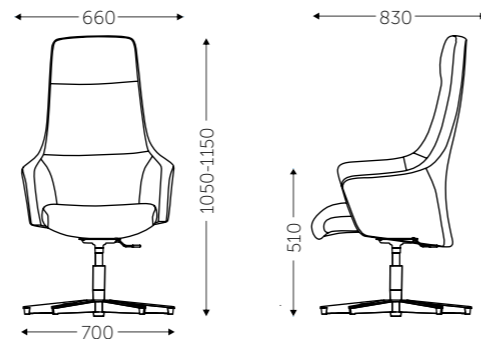
INDIGO



Aluminium Base



W 700 x D 500 x H 450-520



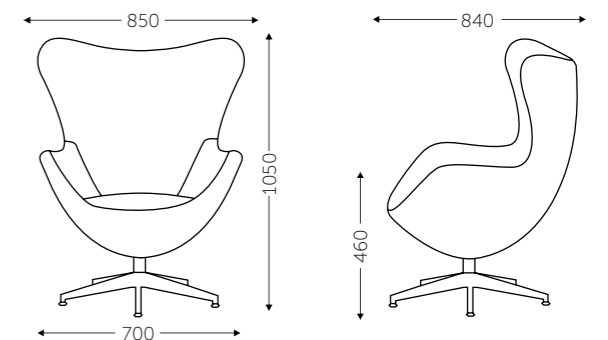
GLORIA



Aluminium Base



W 700 x D 520 x H 450-550



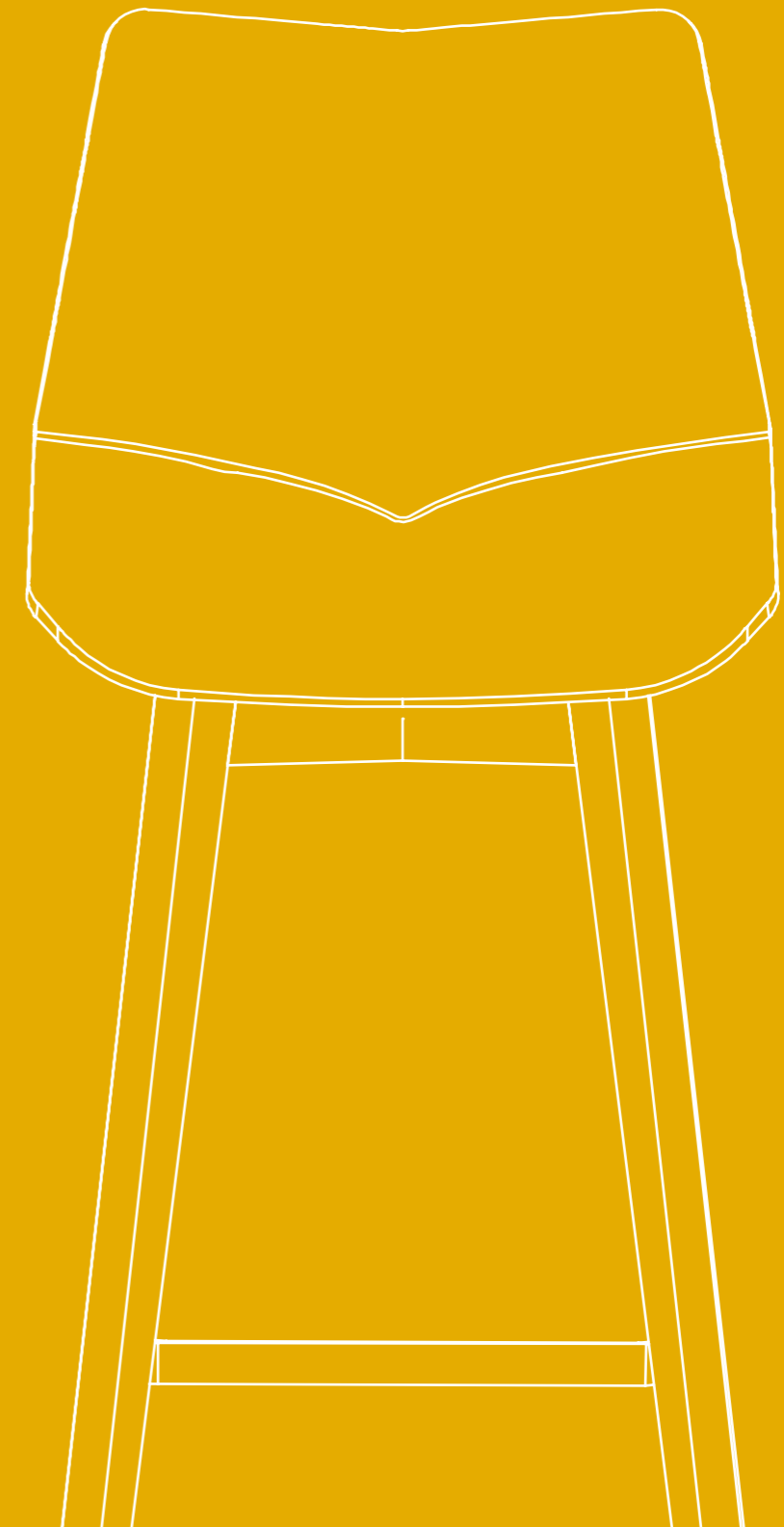


High Chairs & Tables

At Featherlite, we offer a vast array of attractive and functional bar chairs and tables for any environment.

High Stools are an ideal choice for use in a number of different environments where additional height is required such as cafes, restaurants, bars and dining areas. Café, Bar and restaurant stools provide a more relaxed seating solution that can transform any environment.

High Tables are sleek and stylish in design, offering high, casual spaces for catching up and engaging with one another.



04

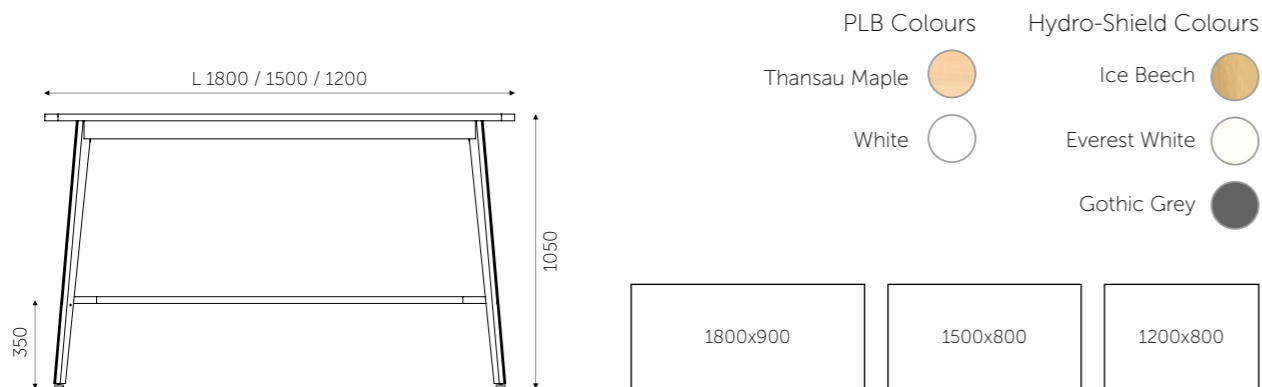
HIGH TABLE

WOODEN LEGS



Table Top: PLB (for non cafeteria use)
 Hydro-Shield (for cafeteria use, Edge finishing will be black)
 Legs: Solid Wood Legs with Metal Footrest

Chair: Zella Solid Wood Legs



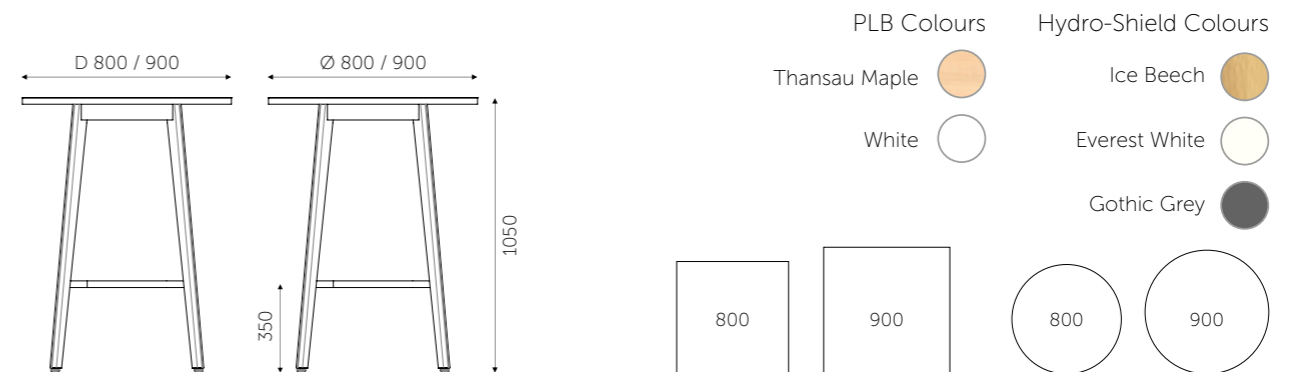
HIGH TABLE

WOODEN LEGS



Table Top: PLB (for non cafeteria use)
 Hydro-Shield (for cafeteria use, Edge finishing will be black)
 Legs: Solid Wood Legs with Metal Footrest

Chair: Leaf Solid Wood Legs



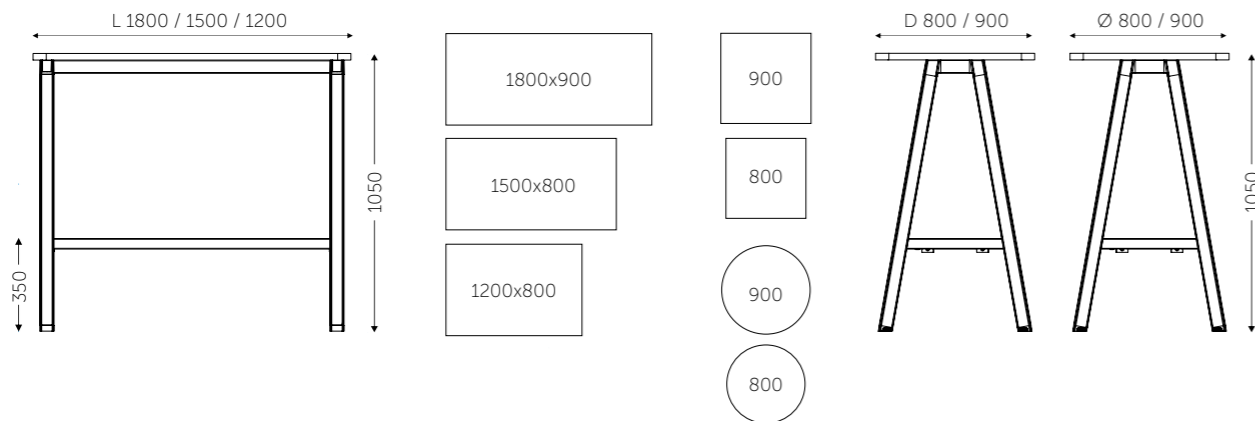
HIGH TABLE

SWITCH - METAL ANGULAR LEGS



Table Top: PLB (for non cafeteria use)
Hydro-Shield (for cafeteria use, Edge finishing will be black)
Legs: Metal

Chair: Leaf Cushion



Hydro-Shield Colours

- Ice Beech
- Everest White
- Gothic Grey

PLB Colours

- Thansau Maple
- White

Metal Powder Coating Colours

- Moon Light Grey
- Ivory
- White
- Black
- Dark Grey
- Silver Grey

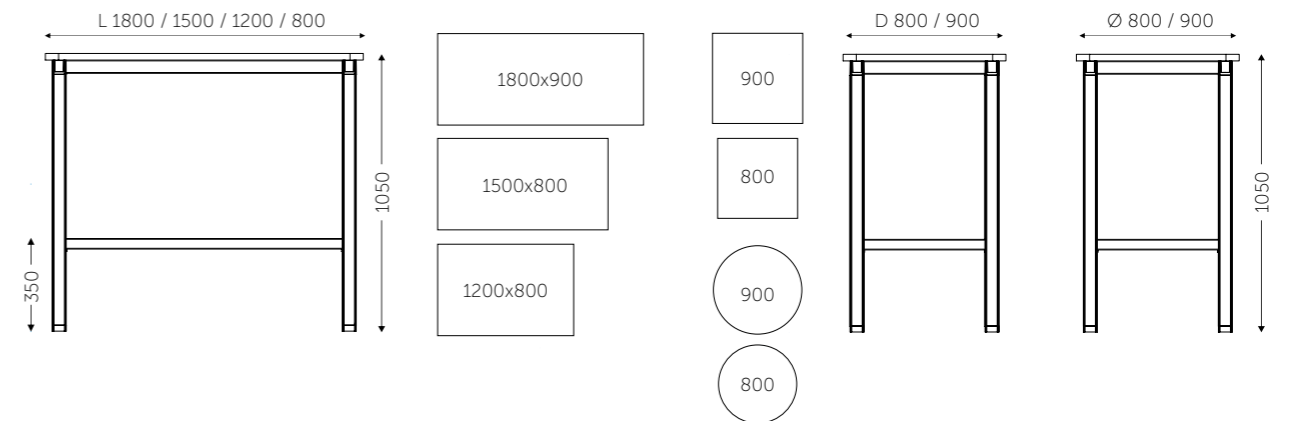
HIGH TABLE

SWITCH - METAL STRAIGHT LEGS



Table Top: PLB (for non cafeteria use)
Hydro-Shield (for cafeteria use, Edge finishing will be black)
Legs: Metal

Chair: Leaf Cushion



Hydro-Shield Colours

- Ice Beech
- Everest White
- Gothic Grey

PLB Colours

- Thansau Maple
- White

Metal Powder Coating Colours

- Moon Light Grey
- Ivory
- White
- Black
- Dark Grey
- Silver Grey



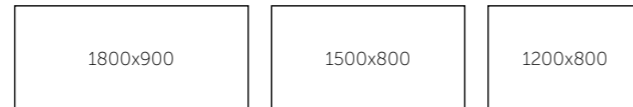
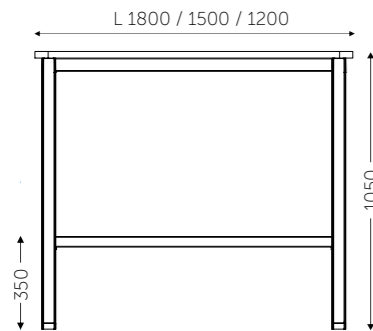
HIGH TABLE

PERFORM - METAL LEGS



Table Top: PLB (for non cafeteria use)
Hydro-Shield (for cafeteria use, Edge finishing will be black)
Legs: Metal

Chair: Loop Cushion



Hydro-Shield Colours

- Ice Beech
- Everest White
- Gothic Grey

PLB Colours

- Thansau Maple
- White

Metal Powder Coating Colours

- Moon Light Grey
- Ivory
- White
- Black
- Dark Grey
- Silver Grey

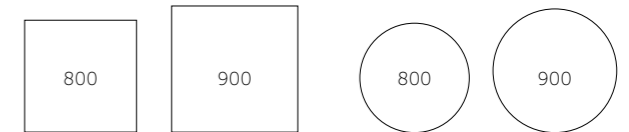
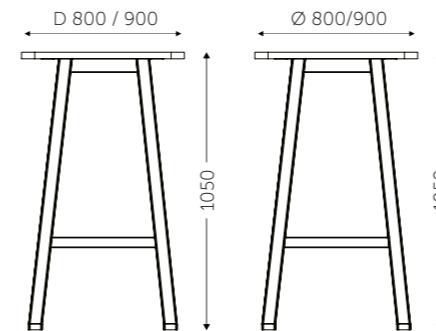
HIGH TABLE

PERFORM - METAL LEGS



Table Top: PLB (for non cafeteria use)
Hydro-Shield (for cafeteria use, Edge finishing will be black)
Legs: Metal

Chair: Loop Cushion



Hydro-Shield Colours

- Ice Beech
- Everest White
- Gothic Grey

PLB Colours

- Thansau Maple
- White

Metal Powder Coating Colours




- Moon Light Grey
- Ivory
- White
- Black
- Dark Grey
- Silver Grey

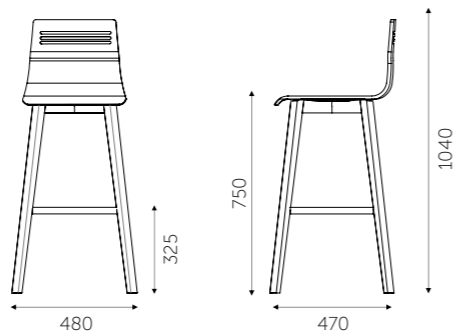
ZELLA WOODEN LEGS



Laminated Plywood Seat with Solid Wood Legs

Laminate Colours

-  Hickory Oak
-  Horizontal Ebony
-  White



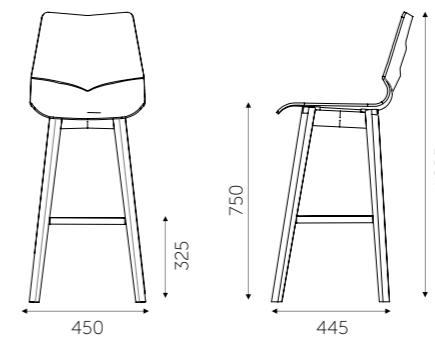
WOODEN LEGS LEAF



PP Seat Colours

- 
- 
- 
- 
- 
- 

Available with or without Cushion Seat.
Legs: Solid Wood



LEAF METAL LEGS



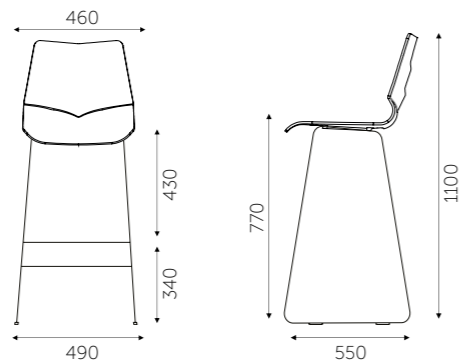
PP Seat Colours



Frame Colours



Available with or without Cushion Seat.
Frame: Metal Powder Coated



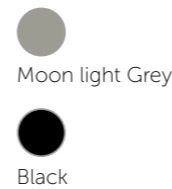
METAL LEGS LOOP



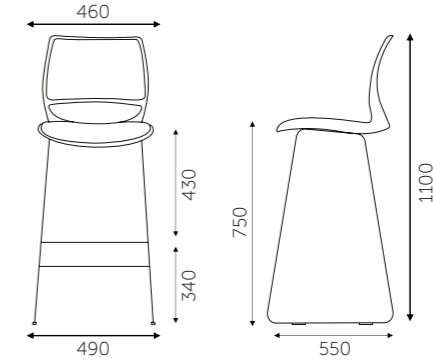
PP Seat Colours



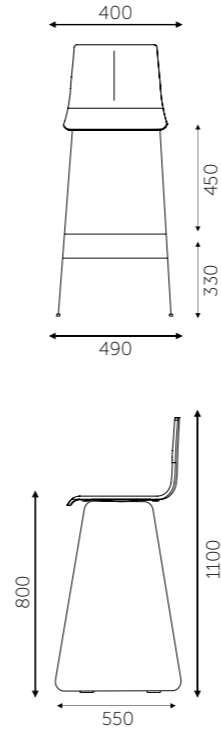
Frame Colours



Available with Cushion Seat & Back only.
Not Available in only Plastic Shell.
Frame: Metal Powder Coated

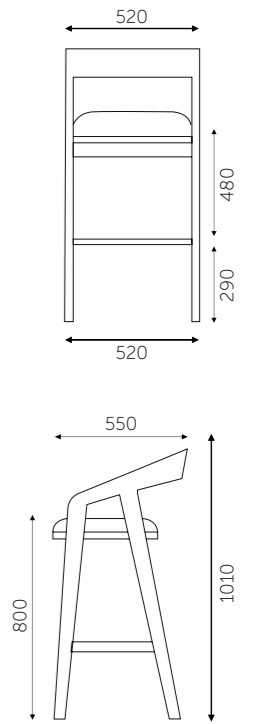


ZELLA

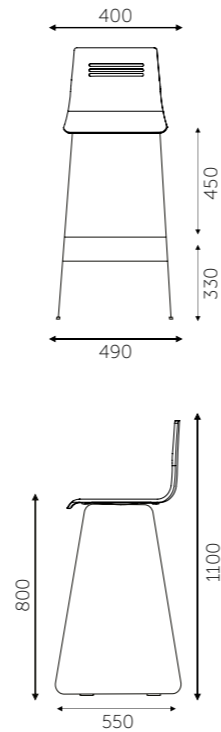


Leatherite / Fabric Seat with Metal Powder Coated Legs

JAVA

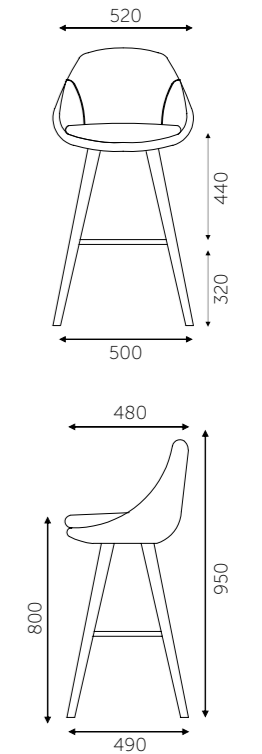


Solid Wood with Cushion Seat



Laminated Plywood Seat with Metal Legs

ARABICA



Solid Wood Legs

ESPRESSO



W 410 x D 410 x H 940

PP Shell with Metal Powder Coated Legs

SEAT COLOURS



POWDER COATING COLOURS



MOJITO



W 520 x D 450 x H 940

POWDER COATING COLOURS



PP Shell with Metal Powder Coated Legs

GIMLET

W 480 x D 535 x H 810



SEAT COLOURS



POWDER COATING COLOURS



Cafe Chairs & Tables

A quick bite or a long break, our Cafeteria/Casual Seating range complement the hangout needs of all at the academy. Sit down for a long round of chatting, an unofficial meeting, discussion work, or even an academic event planning while lunching with your peers. What's more, there is no fuss, cleaning the mess, thanks to the stain free materials this range is made of.

Some of these chairs are stackable, washable if there were any spills, readily available to arrange and use and available in an assortment of colours.



05

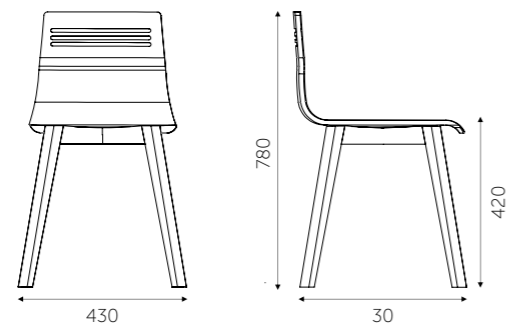
ZELLA WOOD



Laminated Plywood Seat with Solid Wood Legs

Laminate Colours

- Hickory Oak
- Horizontal Ebony
- White



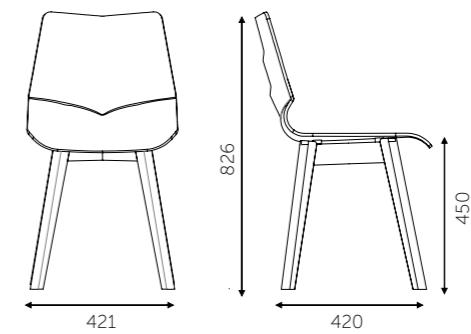
LEAF WOOD



Available with or without Cushion Seat with Solid Wood Legs

PP Seat Colours

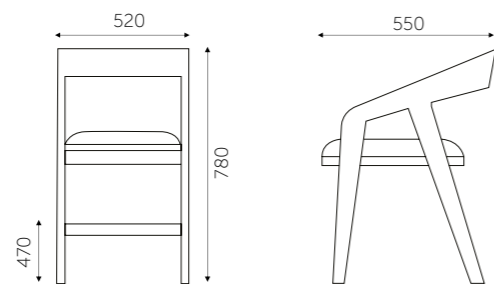
-
-
-
-
-
-



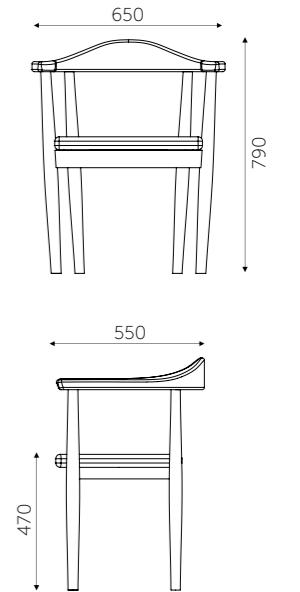
BASIL



Solid Wood with Cushion Seat

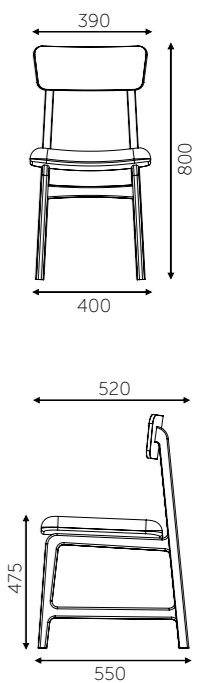


BOSCO



Solid Wood with Cushion Seat

BURRO



Solid Wood with Cushion Seat

TANG



RED



BLACK



GREEN



WHITE



ORANGE



GREY



LEAF SLEDGE BASE



W 530 x D 500 x H 800

Frame Colours

● Moon light Grey

● Black

PP Seat Colours



Available with or without Cushion Seat.
Frame: Metal Powder Coated

CUSHION LEAF



W 530 x D 500 x H 800

Frame Colours

● Moon light Grey

● Black

PP Seat Colours



Available with or without Cushion Seat.
Frame: Metal Powder Coated

LEAF 4 LEGS



W 515 x D 500 x H 800

Frame Colours

● Moon light Grey

● Black

PP Seat Colours



Available with or without Cushion Seat.
Frame: Metal Powder Coated

CUSHION LOOP



W 535 x D 535 x H 840

Frame Colours

● Moon light Grey

● Black

PP Seat Colours



Available with Cushion Seat & Back only.
Not Available in only Plastic Shell.
Frame: Metal Powder Coated

CANDITI



COLOUR VARIATIONS



POWDER COATING COLOURS



MAIS



COLOUR VARIATIONS



POWDER COATING COLOURS



FAME



COLOUR VARIATIONS



POWDER COATING COLOURS



FORNO



SEAT COLOURS



POWDER COATING COLOURS



GUSTO



W 450 x D 510 x H 780
PP Shell with Metal Powder Coated Legs
Available with or without Cushion Seat

COLOUR VARIATIONS



POWDER COATING COLOURS



AIR



W 590 x D 590 x H 800
Single Plastic Moulded Chair

COLOUR VARIATIONS



CRUDO



W 495 x D 520 x H 775
Single Plastic Moulded Chair

COLOUR VARIATIONS



NOCI



W 480 x D 540 x H 820
Single Plastic Moulded Chair

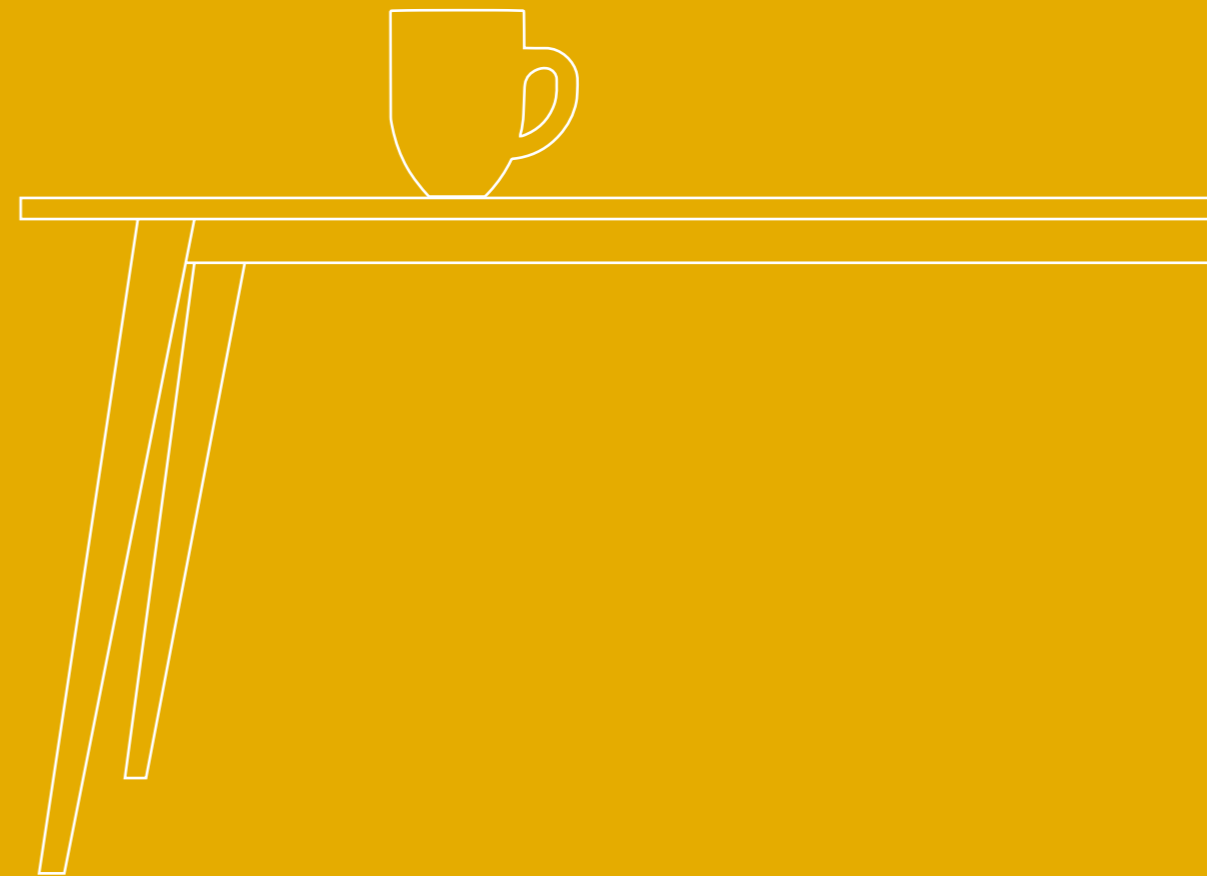
COLOUR VARIATIONS





Center Tables

06



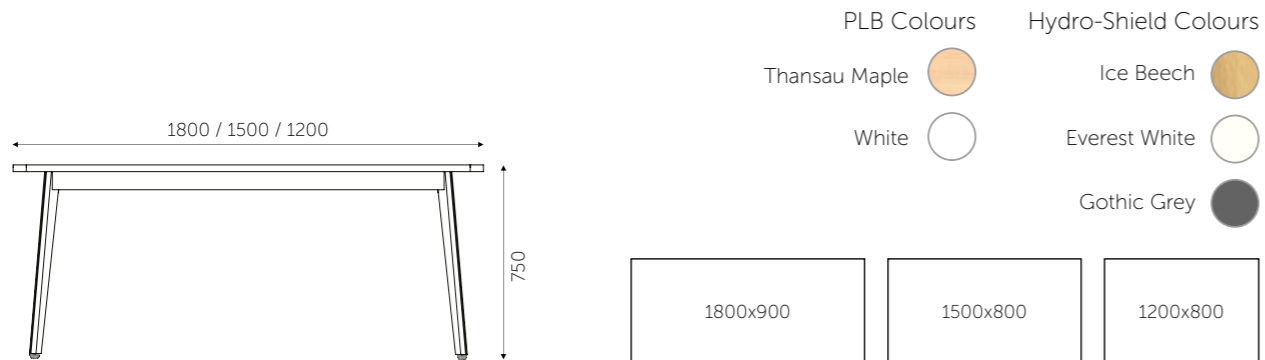
TABLES

WOODEN LEGS



Table Top: PLB (for non cafeteria use)
 Hydro-Shield (for cafeteria use, Edge finishing will be black)
 Legs: Solid Wood

Chair: Leaf Wooden Legs



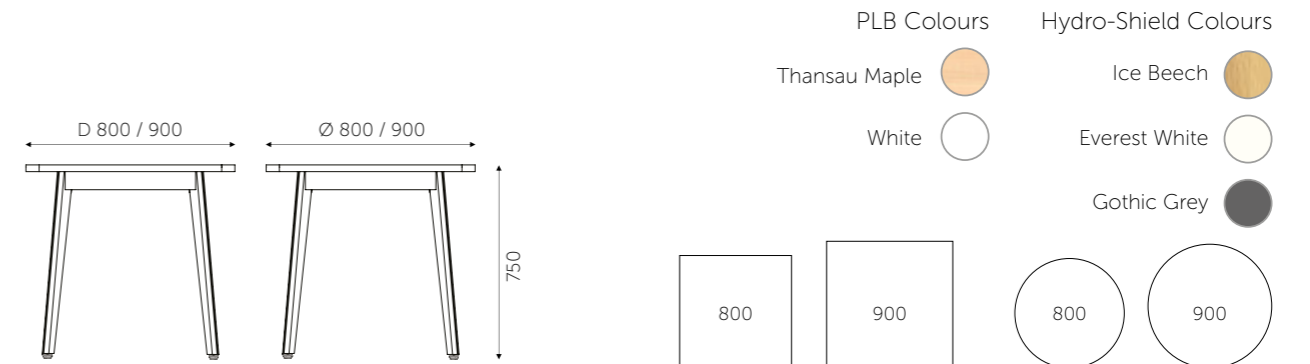
TABLES

WOODEN LEGS



Table Top: PLB (for non cafeteria use)
 Hydro-Shield (for cafeteria use, Edge finishing will be black)
 Legs: Solid Wood

Chair: Zella Wooden Legs



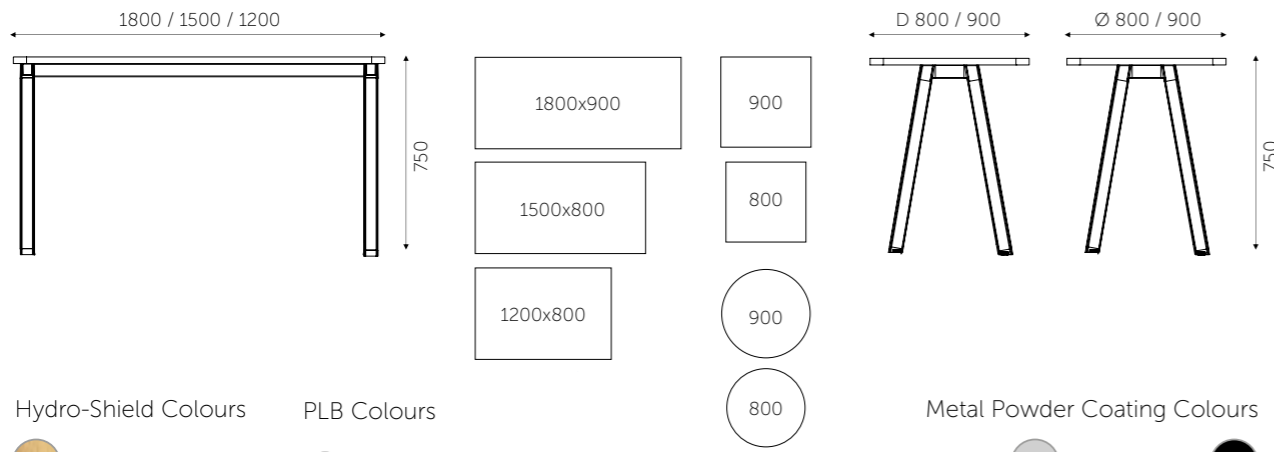
TABLES

SWITCH ANGULAR - METAL LEGS



Table Top: PLB (for non cafeteria use)
Hydro-Shield (for cafeteria use, Edge finishing will be black)
Legs: Metal

Chair: Loop Cushion



Hydro-Shield Colours

- Ice Beech
- Everest White
- Gothic Grey

PLB Colours

- Thansau Maple
- White

Metal Powder Coating Colours

- Moon Light Grey
- Ivory
- White
- Black
- Dark Grey
- Silver Grey

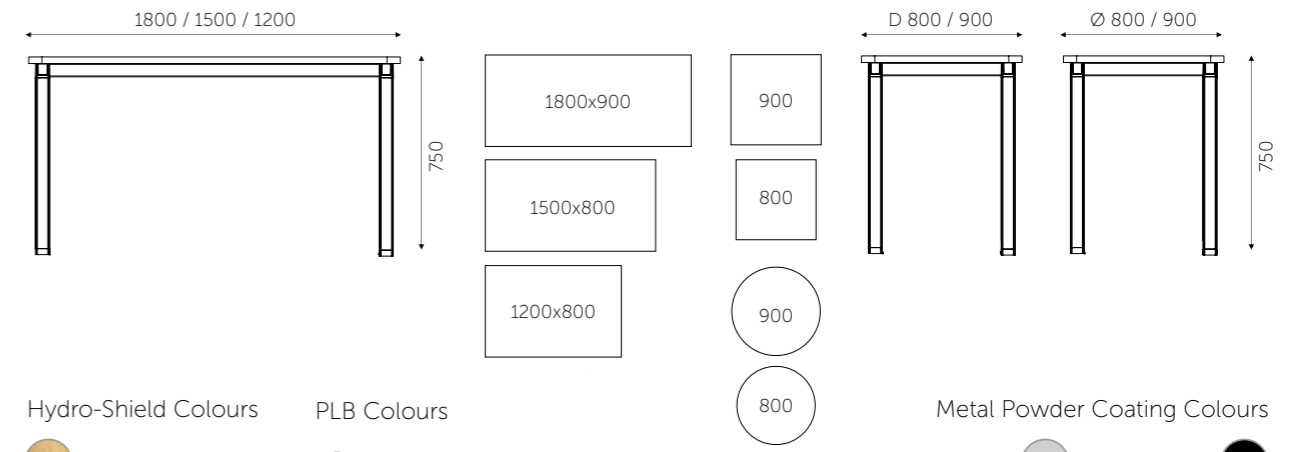
TABLES

SWITCH STRAIGHT - METAL LEGS



Table Top: PLB (for non cafeteria use)
Hydro-Shield (for cafeteria use, Edge finishing will be black)
Legs: Metal

Chair: Leaf Cushion



Hydro-Shield Colours

- Ice Beech
- Everest White
- Gothic Grey

PLB Colours

- Thansau Maple
- White

Metal Powder Coating Colours

- Moon Light Grey
- Ivory
- White
- Black
- Dark Grey
- Silver Grey

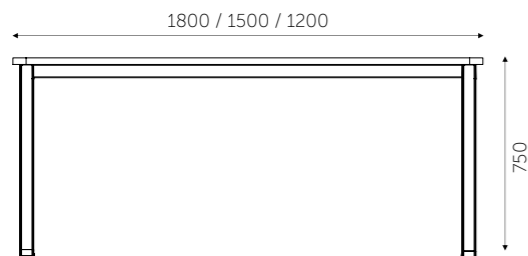
TABLES

PERFORM - METAL LEGS



Table Top: PLB (for non cafeteria use)
Hydro-Shield (for cafeteria use, Edge finishing will be black)
Legs: Metal

Chair: Loop Cushion



Hydro-Shield Colours

- Ice Beech
- Everest White
- Gothic Grey

PLB Colours

- Thansau Maple
- White

Metal Powder Coating Colours

- Moon Light Grey
- Ivory
- White
- Black
- Dark Grey
- Silver Grey

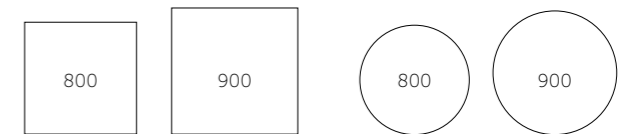
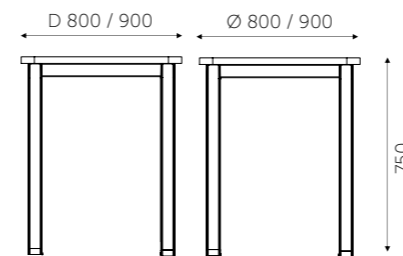
TABLES

PERFORM - METAL LEGS



Table Top: PLB (for non cafeteria use)
Hydro-Shield (for cafeteria use, Edge finishing will be black)
Legs: Metal

Chair: Leaf Cushion



Hydro-Shield Colours

- Ice Beech
- Everest White
- Gothic Grey

PLB Colours

- Thansau Maple
- White

Metal Powder Coating Colours

- Moon Light Grey
- Ivory
- White
- Black
- Dark Grey
- Silver Grey

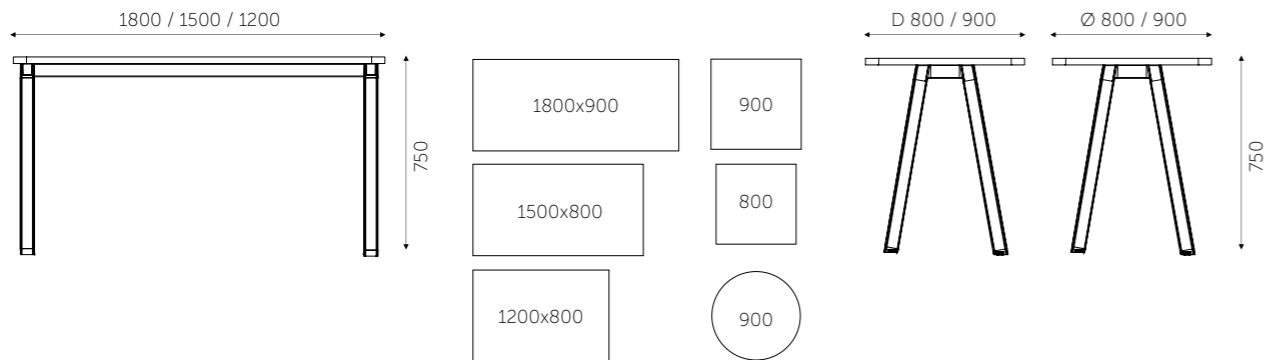
TABLES

SYNERGY - METAL LEGS



Table Top: PLB (for non cafeteria use)
Hydro-Shield (for cafeteria use, Edge finishing will be black)
Legs: Metal

Chair: Loop Cushion



Hydro-Shield Colours

- Ice Beech
- Everest White
- Gothic Grey

PLB Colours

- Thansau Maple
- White

Metal Powder Coating Colours

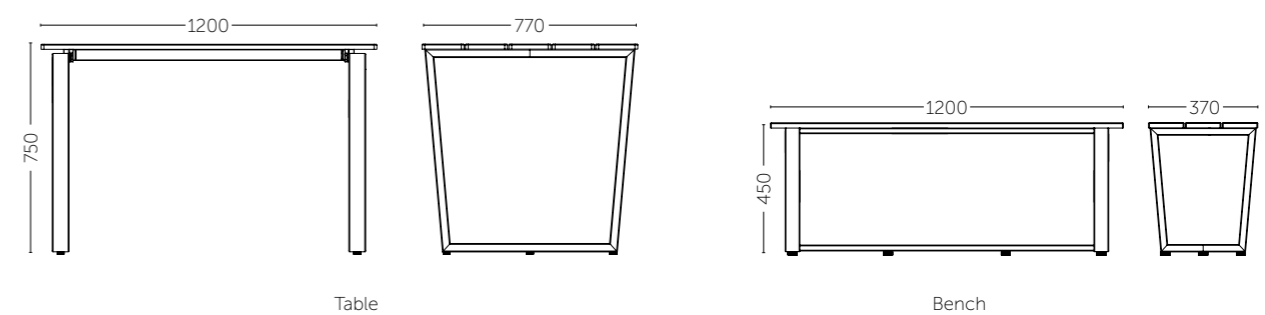
- Moon Light Grey
- White
- Black
- Dark Grey
- Silver Grey

LOOP

TABLE & BENCH



Table & Bench Top: Rubber Wood | Legs: Metal Powder Coated



Rubber Wood Colours

- Walnut
- Natural Clear

Powder Coating Colours

- Black
- Dark Grey
- Moon Light Grey

CENTER TABLES

SOLID WOOD LEGS

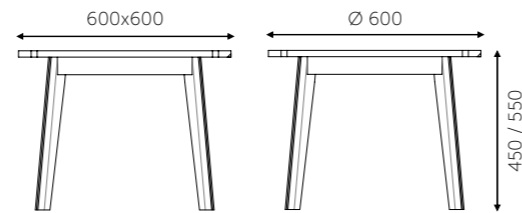


Table Top: PLB (for non cafeteria use) & Hydro-Shield (for cafeteria use, Edge finishing will be black) | Legs: Solid Wood Legs

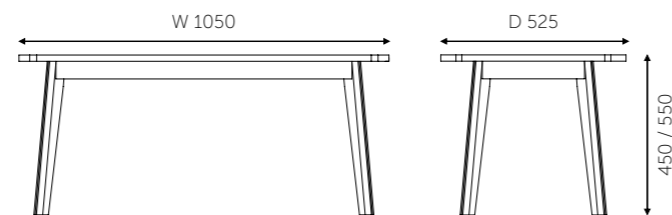


PLB Colours

- Thansau Maple
- White

Hydro-Shield Colours

- Ice Beech
- Everest White
- Gothic Grey



CENTER TABLES

METAL LEGS



RECTANGLE SHAPE
L 1050 x D 600 x H 450 / 550



OVAL SHAPE
L 1050 x D 600 x H 450 / 550

Table Top: PLB (for non cafeteria use) & Hydro-Shield (for cafeteria use, Edge finishing will be black) | Legs: Metal Powder Coated



ROUND SHAPE
Ø 600 x H 450 / 550



SQUARE SHAPE
L 600 x D 600 x H 450 / 550

PLB Colours

- Thansau Maple
- White

Hydro-Shield Colours

- Ice Beech
- Everest White
- Gothic Grey

Powder Coating Colours

- Black
- Dark Grey
- Moon Light Grey



MAJESTIC

METAL LEGS

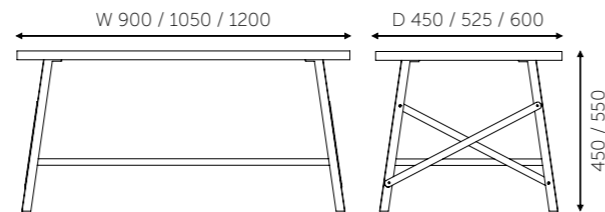
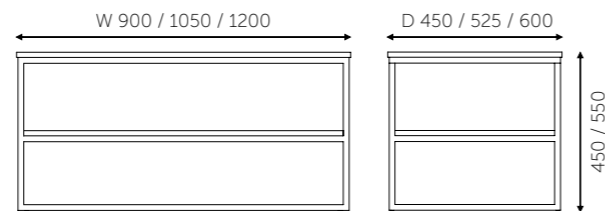


Table Top: PLB (for non cafeteria use), Stained Rubber Wood & Hydro-Shield (for cafeteria use, Edge finishing will be black)

REGAL

METAL LEGS



PLB Colours

- Thansau Maple
- White

Hydro-Shield Colours

- Ice Beech
- Everest White
- Gothic Grey

Stained Rubber Wood Colours

- Walnut
- Natural Clear

Powder Coating Colours

- Black
- Dark Grey
- Moon Light Grey

TRANQUIL

METAL LEGS

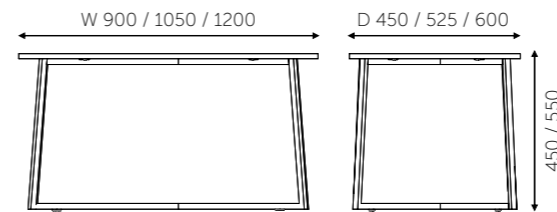
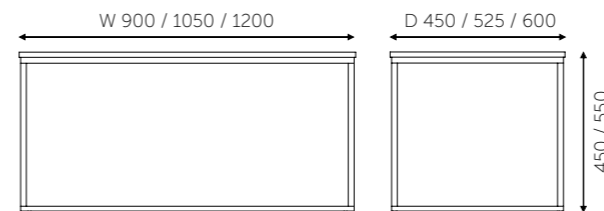


Table Top: PLB (for non cafeteria use), Stained Rubber Wood & Hydro-Shield (for cafeteria use, Edge finishing will be black)

HARMONY

METAL LEGS



PLB Colours

- Thansau Maple
- White

Hydro-Shield Colours

- Ice Beech
- Everest White
- Gothic Grey

Stained Rubber Wood Colours

- Walnut
- Natural Clear

Powder Coating Colours

- Black
- Dark Grey
- Moon Light Grey

ELEGANCE

METAL LEGS

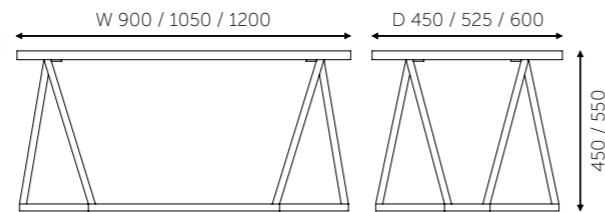
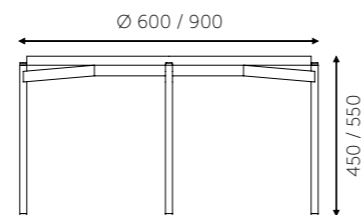


Table Top: PLB (for non cafeteria use), Stained Rubber Wood & Hydro-Shield (for cafeteria use, Edge finishing will be black)

GLAMOUR

METAL LEGS



- | | | | |
|--------------------|-----------------------------|------------------------------------|-------------------------------|
| PLB Colours | Hydro-Shield Colours | Stained Rubber Wood Colours | Powder Coating Colours |
| Thansau Maple | Ice Beech | Walnut | Black |
| White | Everest White | Natural Clear | Dark Grey |
| | Gothic Grey | | Moon Light Grey |

GRACE

METAL LEGS

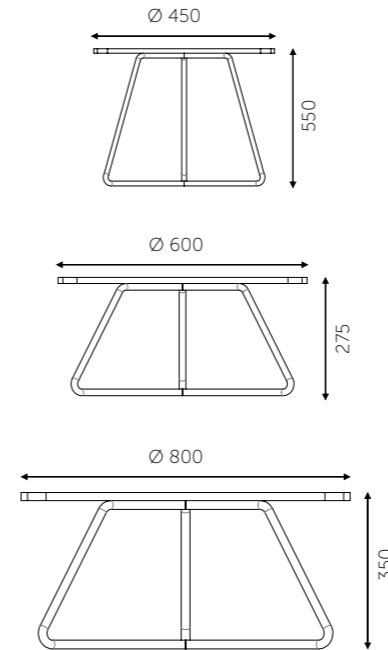
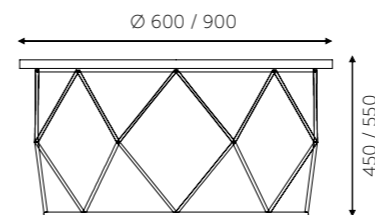


Table Top: PLB (for non cafeteria use), Stained Rubber Wood & Hydro-Shield (for cafeteria use, Edge finishing will be black)

COSMO

METAL LEGS



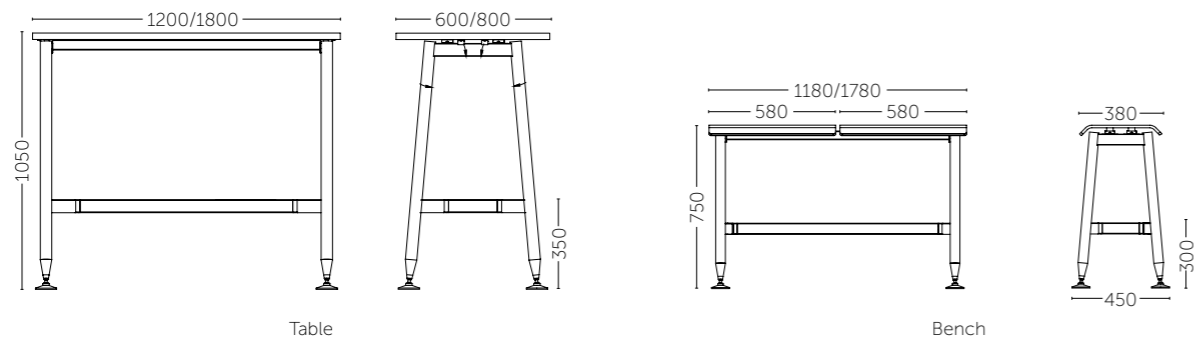
- | | | | |
|--------------------|-----------------------------|------------------------------------|-------------------------------|
| PLB Colours | Hydro-Shield Colours | Stained Rubber Wood Colours | Powder Coating Colours |
| Thansau Maple | Ice Beech | Walnut | Black |
| White | Everest White | Natural Clear | Dark Grey |
| | Gothic Grey | | Moon Light Grey |

FLOAT

HIGH TABLE & BENCH



Table Top: PLB (for non cafeteria use) & Hydro-Shield (for cafeteria use, Edge finishing will be black)
 Bench Top: Moulded Plywood with or without Cushion Seat | Legs: Metal Powder Coated

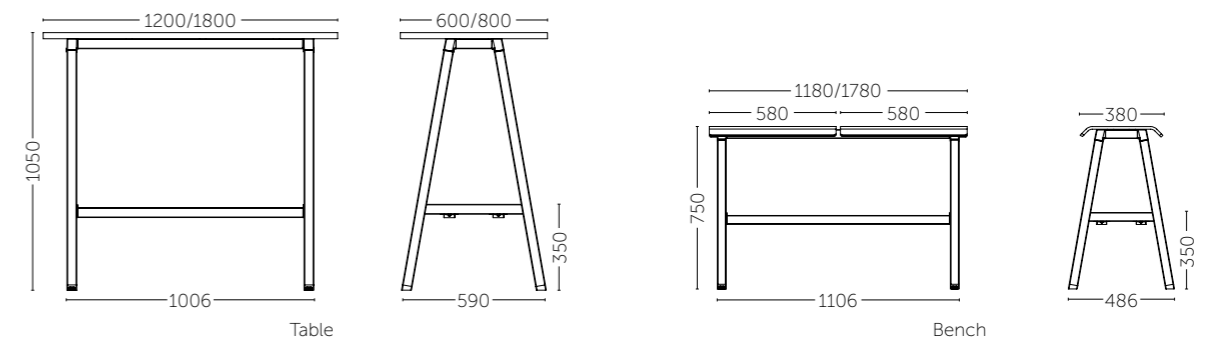


SWITCH

HIGH TABLE & BENCH

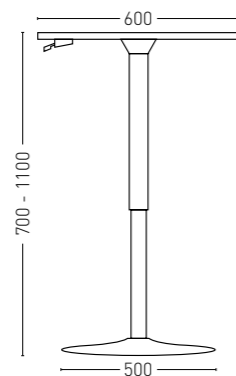


Table Top: PLB (for non cafeteria use) & Hydro-Shield (for cafeteria use, Edge finishing will be black)
 Bench Top: Moulded Plywood with or without Cushion Seat | Legs: Metal Powder Coated



IRIS

HEIGHT ADJUSTABLE TABLE



LYRA

Table Top: ISO & Hydro-Shield (for cafeteria use), Hydro-Shield Edge finishing will be black) | Legs: Metal Powder Coated





L 1200 x D 800 x H 750
L 1500 x D 900 x H 750



Ø 914 x H 750



ISO Table Top Colours

-  Thansau Maple
-  White

Hydro-Shield Colours

-  Ice Beech
-  Everest White
-  Gothic Grey

ATLAS

Table Top: ISO & Hydro-Shield (for cafeteria use), Hydro-Shield Edge finishing will be black) | Legs: SS



L 1200 x D 800 x H 750
L 1500 x D 900 x H 750



L 800 x D 800 x H 750



Ø 914 x H 750



ISO Table Top Colours

- Thansau Maple
- White

Hydro-Shield Colours

- Ice Beech
- Everest White
- Gothic Grey

LUCAS

Table Top: ISO & Hydro-Shield (for cafeteria use), Hydro-Shield Edge finishing will be black) | Legs: Metal Powder Coated



L 1200 x D 800 x H 750
L 1500 x D 900 x H 750



L 800 x D 800 x H 750



Ø 914 x H 750



ISO Table Top Colours

- Thansau Maple
- White

Hydro-Shield Colours

- Ice Beech
- Everest White
- Gothic Grey

Metal Powder Coating Colours

- Moon Light Grey
- Ivory
- White
- Black
- Dark Grey
- Silver Grey

CAFE CHROME

Table Top: ISO & Hydro-Shield (for cafeteria use), Hydro-Shield Edge finishing will be black) | Legs: Chrome



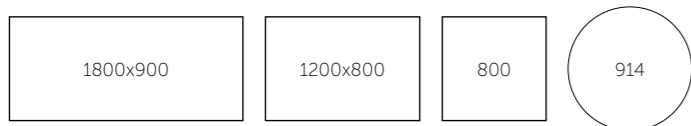
L 1200 x D 800 x H 750
L 1800 x D 900 x H 750



L 800 x D 800 x H 750



Ø 914 x H 750



ISO Table Top Colours

- Thansau Maple
- White

Hydro-Shield Colours

- Ice Beech
- Everest White
- Gothic Grey

CAFE FOLD

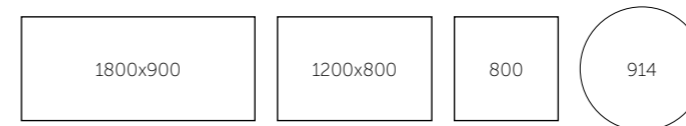
Table Top: ISO & Hydro-Shield (for cafeteria use), Hydro-Shield Edge finishing will be black) | Legs: SS



L 1200 x D 800 x H 750
L 1800 x D 900 x H 750



L 800 x D 800 x H 750 Ø 914 x H 750



ISO Table Top Colours

- Thansau Maple
- White

Hydro-Shield Colours

- Ice Beech
- Everest White
- Gothic Grey



Training

When it comes to designing a training room, furniture plays a crucial role in creating an environment that is conducive to learning and productivity.

Featherlites range of training room furniture is designed to be durable, and flexible enough to accommodate different training styles and activities.

07



NOMAD



TV Space + Marker Board + Storage
 Marker Board: L 1500 / 1200 x H 900 | Storage: L 1500 / 1200 x D 300 x H 300
 L 1560 x D 560 x H 1800mm (for 65" T.V) | L 1260 x D 560 x H 1800mm (for 50" T.V)



TV Space + Marker Board
 L 1560 x D 560 x H 1800mm (for 65" T.V)
 L 1260 x D 560 x H 1800mm (for 50" T.V)
 Marker Board: L 1200 / 1500 x H 900
 Wooden Shelf: L 900 x D 150



TV Space + Full Marker Board
 L 1560 x D 560 x H 1800mm (for 65" T.V)
 L 1260 x D 560 x H 1800mm (for 50" T.V)
 Marker Board: L 1200 / 1500 x H 1650
 Wooden Shelf: L 900 x D 150



2 Sided Full Marker Board
 L 1560 x D 560 x H 1800mm
 L 1260 x D 560 x H 1800mm
 Marker Board: L 1200 / 1500 x H 1650
 Wooden Shelf: L 900 x D 150



Double Side Marker Board with Storage
 L 1560 x D 560 x H 1800mm
 L 1260 x D 560 x H 1800mm
 Marker Board: L 1500 / 1200 x H 900
 Storage: L 1500 / 1200 x D 300 x H 300



Marker Board + Soft Board with Shelf and Planter
 L 1560 x D 560 x H 1800mm
 L 1260 x D 560 x H 1800mm
 Marker Board: L 1500 / 1200 x H 900
 Wodden Shelf: L 1500 / 1200 x D 300 | Planter: L 1500 / 1200 x D 300 x H 200



Movable Shelving Unit
 L 1560 x D 560 x H 1800mm
 L 1260 x D 560 x H 1800mm
 Wooden Shelf: L 1500 / 1200 x D 300



Movable Shelving Unit + Planters
 L 1560 x D 560 x H 1800mm
 L 1260 x D 560 x H 1800mm
 Wooden Shelf: L 1500 / 1200 x D 300
 Planters: L 1500 / 1200 x D 300 x H 200

FOLDING TABLE

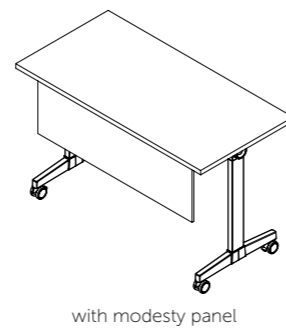
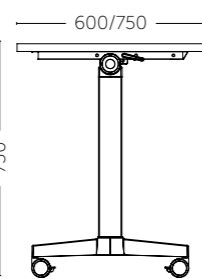
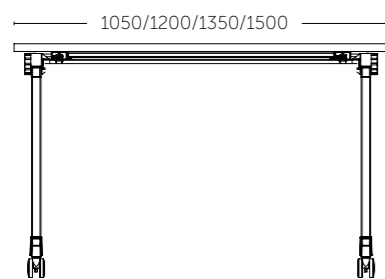
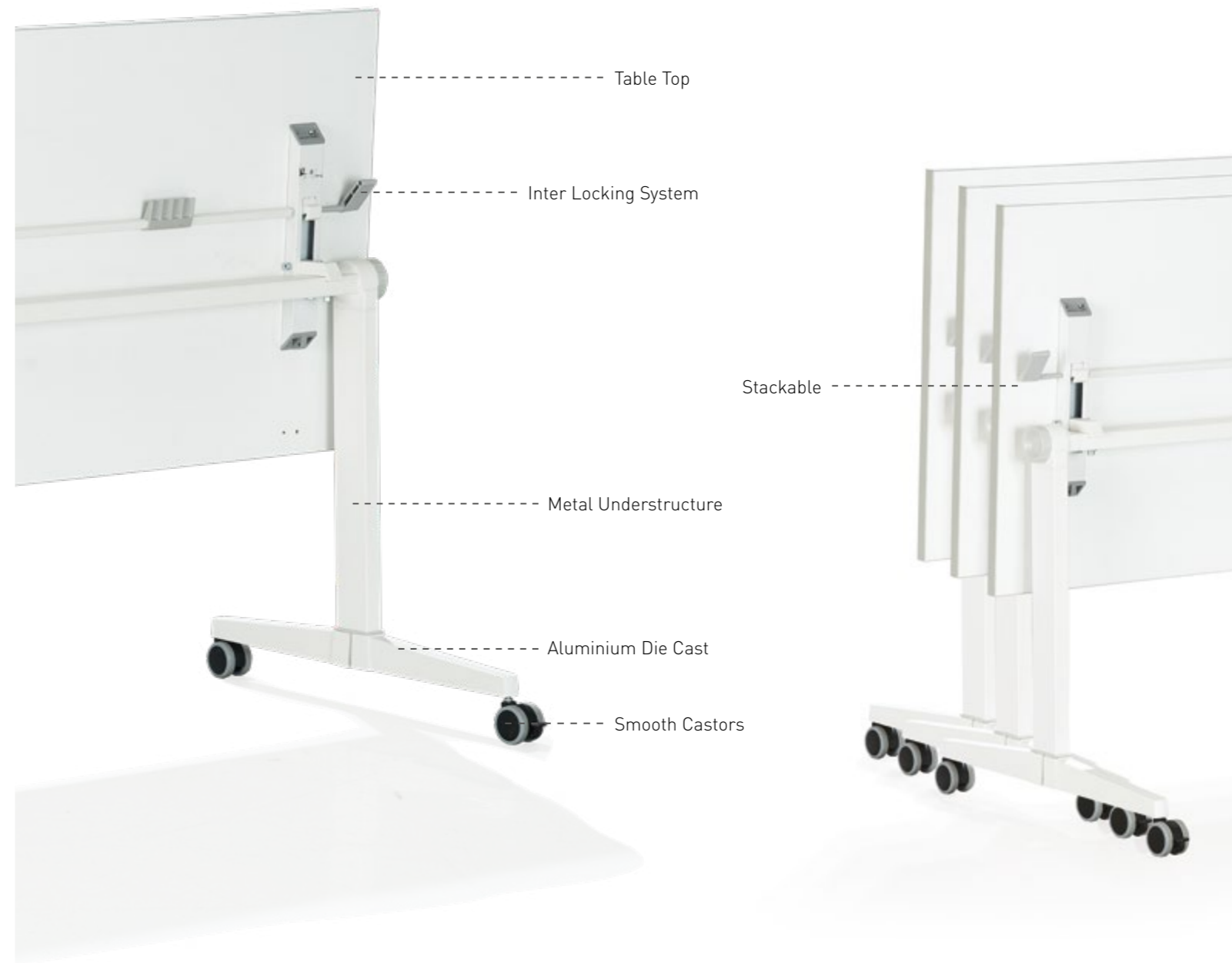
TRAINING & CONFERENCE



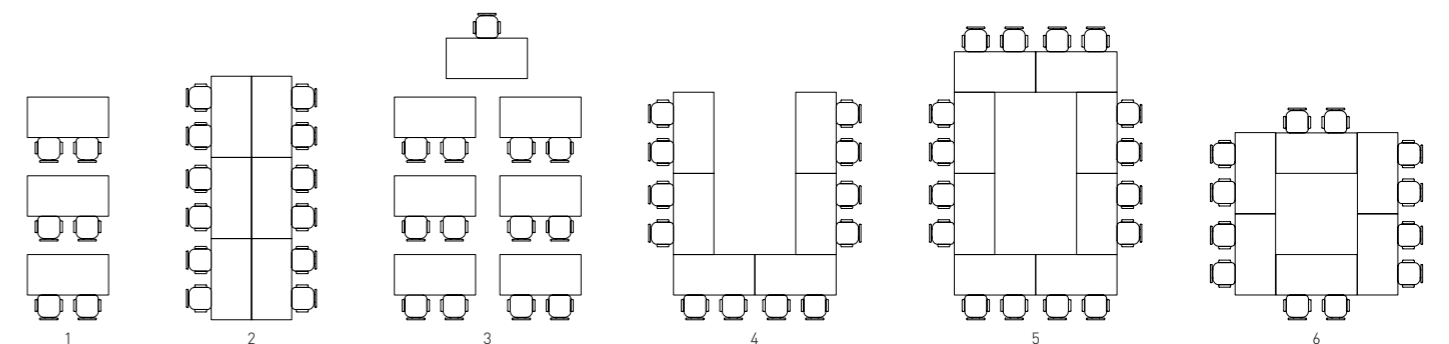
TYPE A



TYPE B



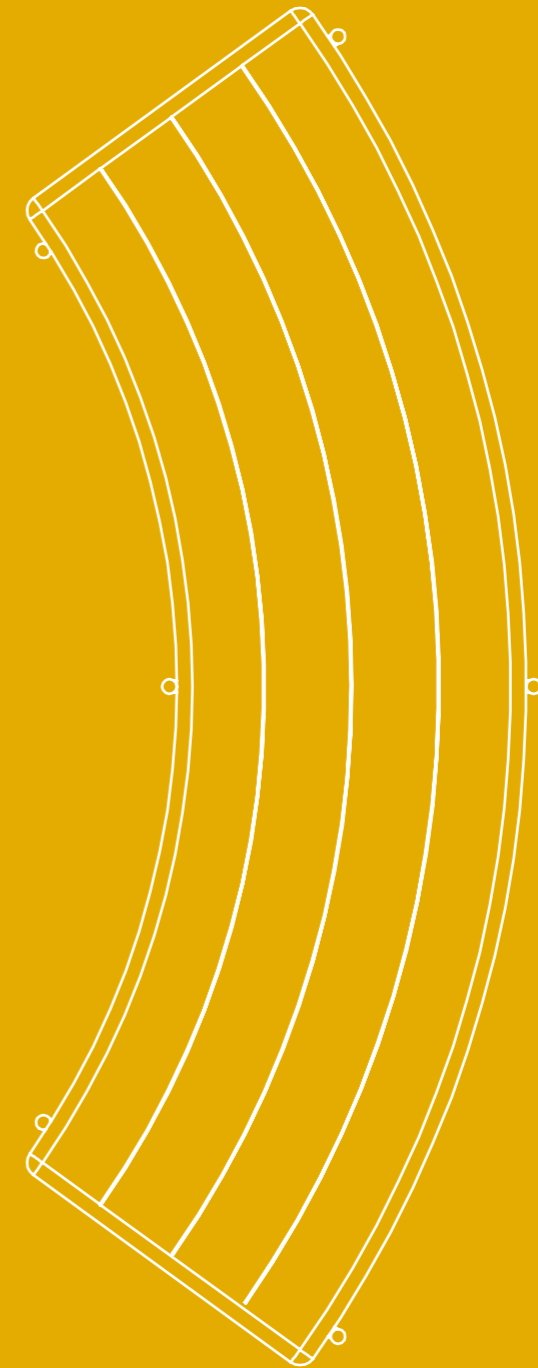
Configurations





Benches

Whether it be through smooth curves or sharp straight lines, our range of contemporary benches add significant character to your workspace. Our benches are movable and reconfigurable to be able to have quick, impromptu meetings anytime, anywhere. Lightweight, yet sturdy in design, Featherlite benches encourage easy and hassle free collaboration. With a vast range of fabric options, these benches add a flair of colour and liveliness to your space.



08

VIVID



CURVED BENCH
L 1750 / 915 x D 450 x H 450



RECTANGLE BENCH
L 1300 x D 450 x H 450



SQUARE BENCH
L 450 x D 450 x H 450



ROUND BENCH
Dia 450 x H 450

VIVID



METAL BENCH



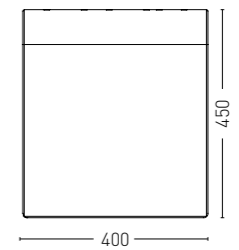
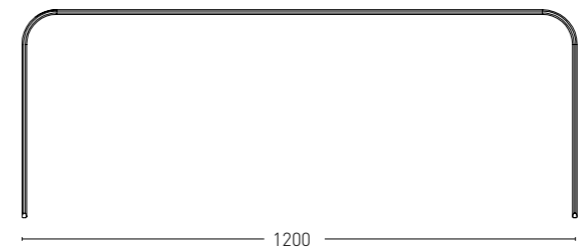
Fluorescent Green



Pink

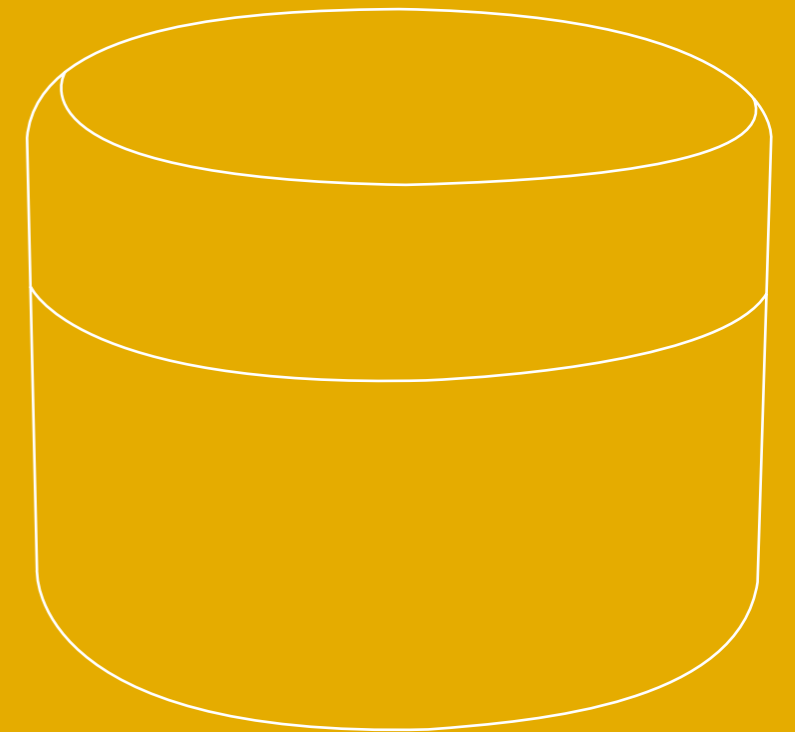


Red



Pouffes

A simple yet highly impactful add on to any workspace, Pouffes allow you to increase the number of seats available in any configuration. Light designs which are easy to move make the pouffe a convenient option when looking for additional seating in any space. Unique shapes and colours of the pouffe give the office space a youthful, and energetic appearance.



09

POUFFE



Circa
W 600 x D 600 x H 450 mm



Cylvia
W 390 x D 390 x H 450 mm



Duo
W 1000 x D 500 x H 395 mm



Conical
Dia 490 / 390 x H 450 mm



Quart de
W 620 x D 450 x H 385 mm



Penta
W 590 x D 570 x H 385 mm



Qube
W 410 x D 390 x H 385 mm



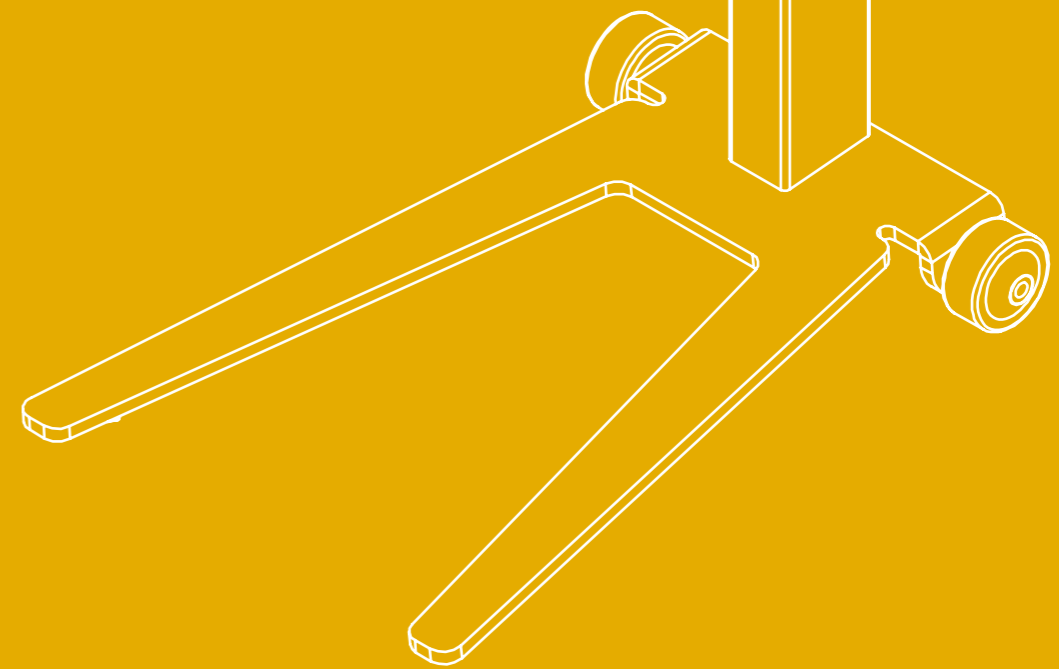
Boomerang
with & without Castors W 650 x D 750 x H 725



Saddle
W 800 x D 400 x H 500

Laptop Tables

Sturdy, yet mobile, our range of Laptop Tables allow users to work or take calls in any space. These sleek designs are easily relocated to where they are required, and fit easily as a necessary accessory to any seating space.

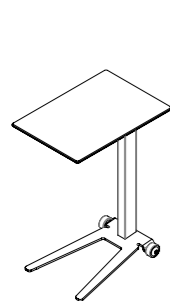


10

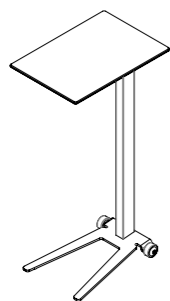
SPIKY



TECHNICAL DETAILS



L 400 x D 500 x H 675 mm



L 450 x D 500 x H 1000 mm

BRISK

Table Top: ISO / Hydro-Shield (for cafeteria use, Edge finishing will be black)



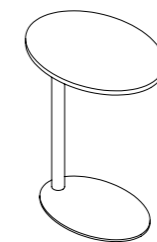
TECHNICAL DETAILS



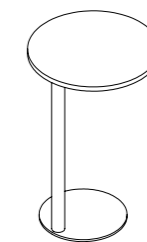
Rectangle
L 550 x D 450 x H 675



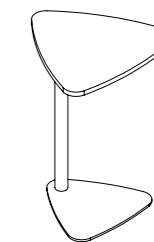
Square
L 450 x D 450 x H 675



Oval
L 550 x D 400 x H 675



Round
Dia 450 x H 675



Triangle
L 465 x D 495 x H 675

ISO Table Top Colours

- Thansau Maple
- White

Hydro-Shield Colours

- Ice Beech

Metal Powder Coating Colours

- Dark Grey
- Moon Light Grey

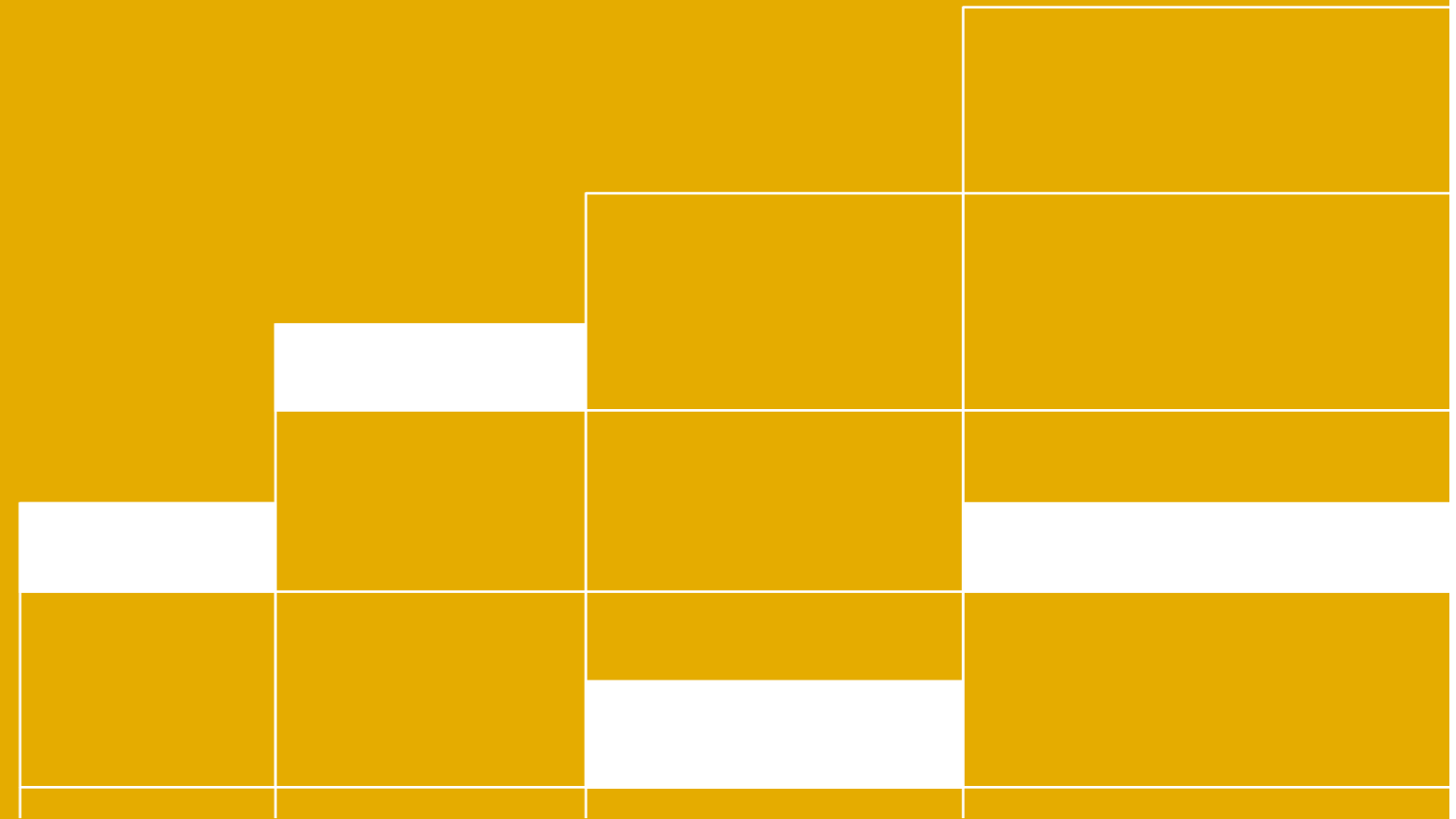
Tetris

Traditional dividers and PVC screens are expensive, not good for the environment and an eyesore.

We're here to change that, our line of dividers harnesses the beauty of nature to enhance your workspace, instead of detracting from it.

Our Tetris range is a fantastic choice for those looking to partition their office and increase their storage capacity. The modular shelves that make up the grid can be provided with a range of interesting attachment options in several different variations.

They can also be paired with a range of planting options and the frame of the grid itself is available in grey, white and black.



TETRIS



Wall display unit
W 600 x D 300 x H 300 mm



Wall display unit
W 900 x D 300 x H 300 mm



Wall display unit
W 1200 x D 300 x H 300 mm



Wall display unit
W 1500 x D 300 x H 300 mm



Wall display unit
W 900 x D 300 x H 140 mm



Display Planter unit
W 2500 x D 400 x H 1975 mm



Display Planter unit
W 2820 x D 400 x H 1805 mm



Display Planter unit
W 1430 x D 300 x H 1155 mm



Storage unit
W 900 x D 400 x H 1775 mm



Storage unit
W 900 x D 400 x H 1775 mm



Storage unit
W 900 x D 400 x H 1775 mm



Storage unit
W 1200 x D 400 x H 1775 mm

TETRIS



Table with storage unit
W 1500 x D 900 x H 750 mm



Table with storage unit
W 1500 x D 1500 x H 750 mm



High Table with storage unit
W 1500 x D 600 x H 1000 mm



Storage & shoe rack unit
W 1800 x D 450 x H 750 mm



Library cum display unit
W 1200 x D 450 x H 1200 mm



Display, Planter with TV unit
W 2120 x D 400 x H 1755 mm



Library cum display unit
W 3780 x D 450 x H 1035 mm









Display & Storage unit with Table
W 2160 x D 400 x H 1615 mm

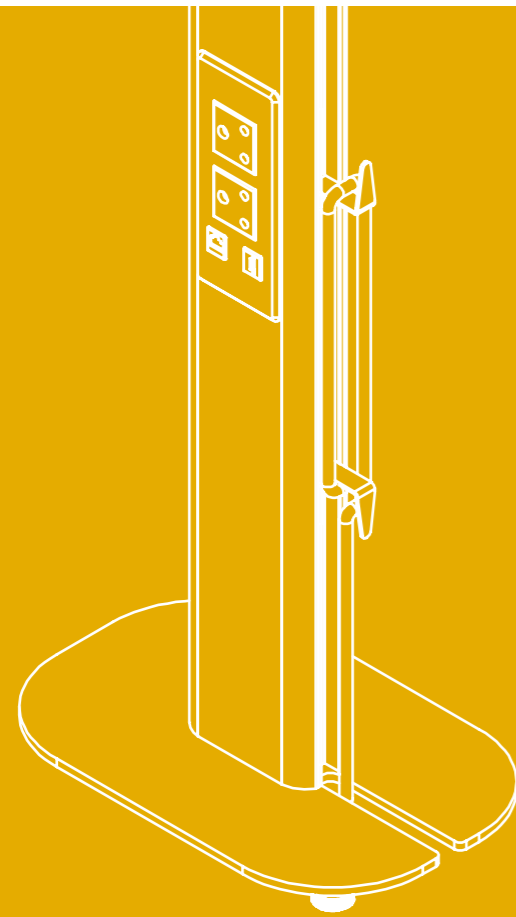


Storage with planter unit
W 2120 x D 1700 x H 1755 mm



Display & library unit with reading space
W 2100 x D 450 x H 1815 mm

- | | | |
|---------------|---|---|
| | PLB | Metal Powder Coating |
| Thansau Maple |  | Black  |
| Everest White |  | White  |
| Gothic Grey |  | Silver Grey  |



Power Tower

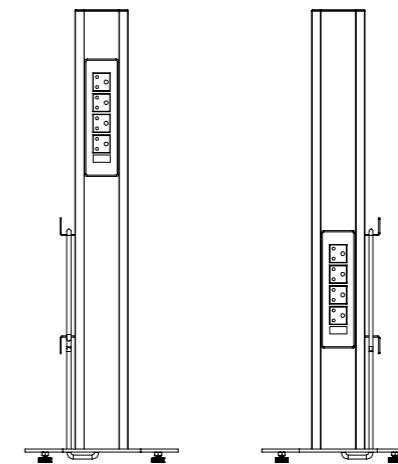
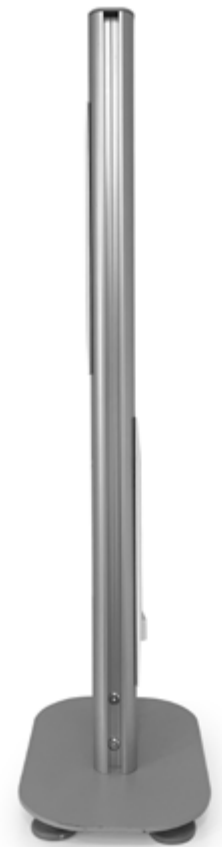
A movable power tower for an office is a compact and convenient solution for powering and charging devices. It features multiple outlets. The tower is designed to be easily moved around the office, making it a versatile addition to any workspace. With its sleek and modern design, it can blend in seamlessly with any office decor. It also ensures safety and security of power supply for all devices in the office, it can also help in reducing the use of multiple power strips, thus reducing the risk of overloading and fire hazards.



Without Castors



With Castors



FRONT

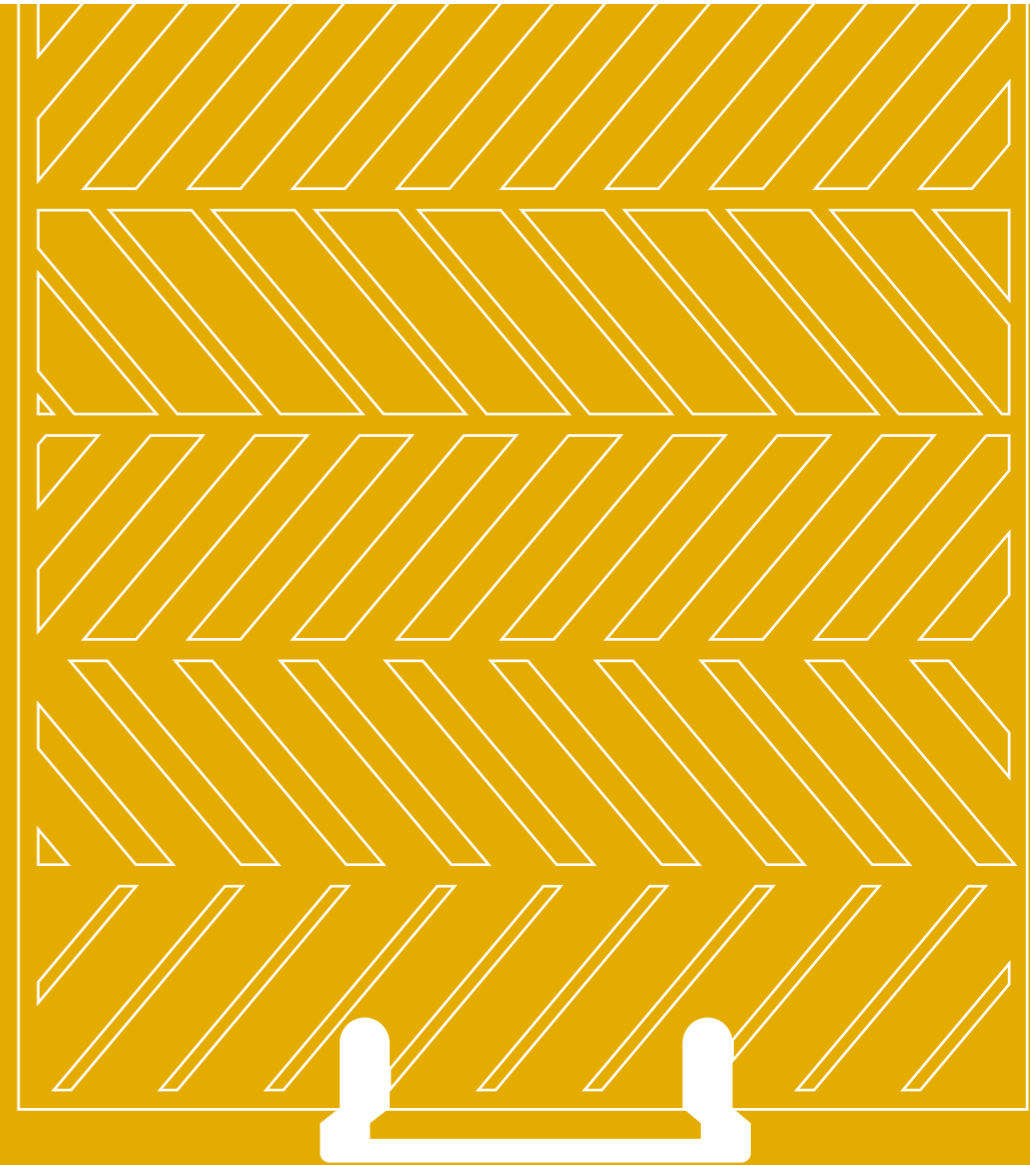
BACK

1 + 1 Switch Plate, 4 Power Sockets in each Plate
L 305 x D 197 x H 900 mm

Acoustic Screens

Rather than create permanent and immovable divisions in your office space, we have created a range of screens to bifurcate the various areas in your office. Our acoustic office dividers, suspended baffles & wall panels are designed to reduce travelling sounds with high-quality acoustic properties & create softer soundscapes. These Screens can be reconfigured at anytime to create either a large open office space which encourages interaction, or siloed departments which encourages focus and growth.

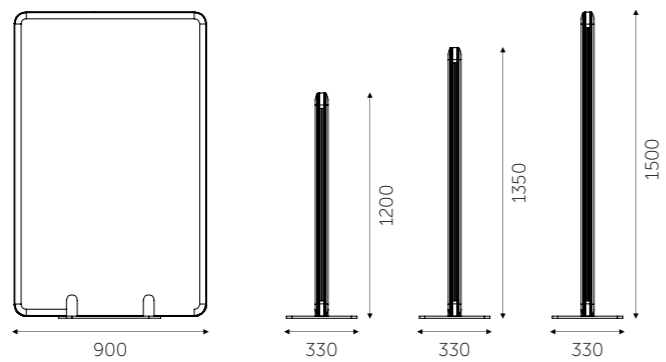
13



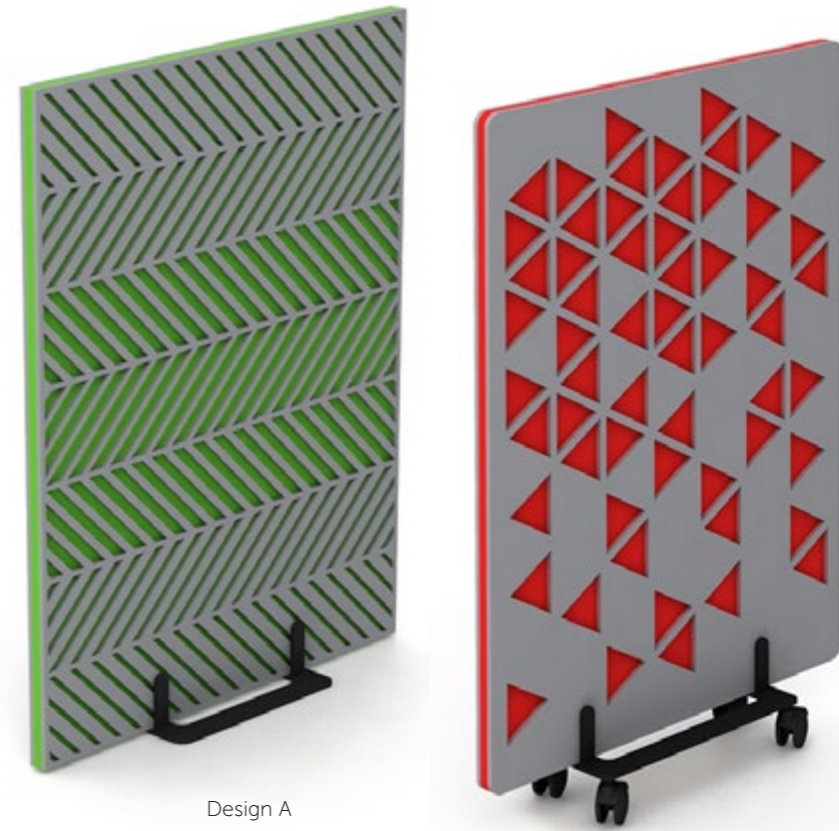
GENESIS FREE STANDING PANELS



Available with and without Castors



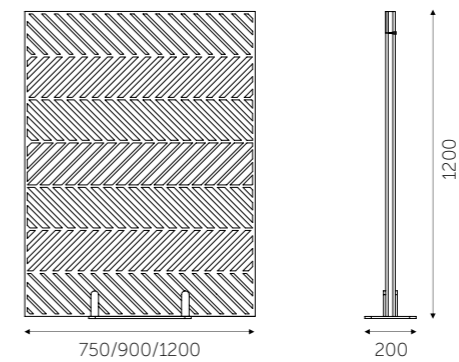
PET PANELS



Design A

Design B

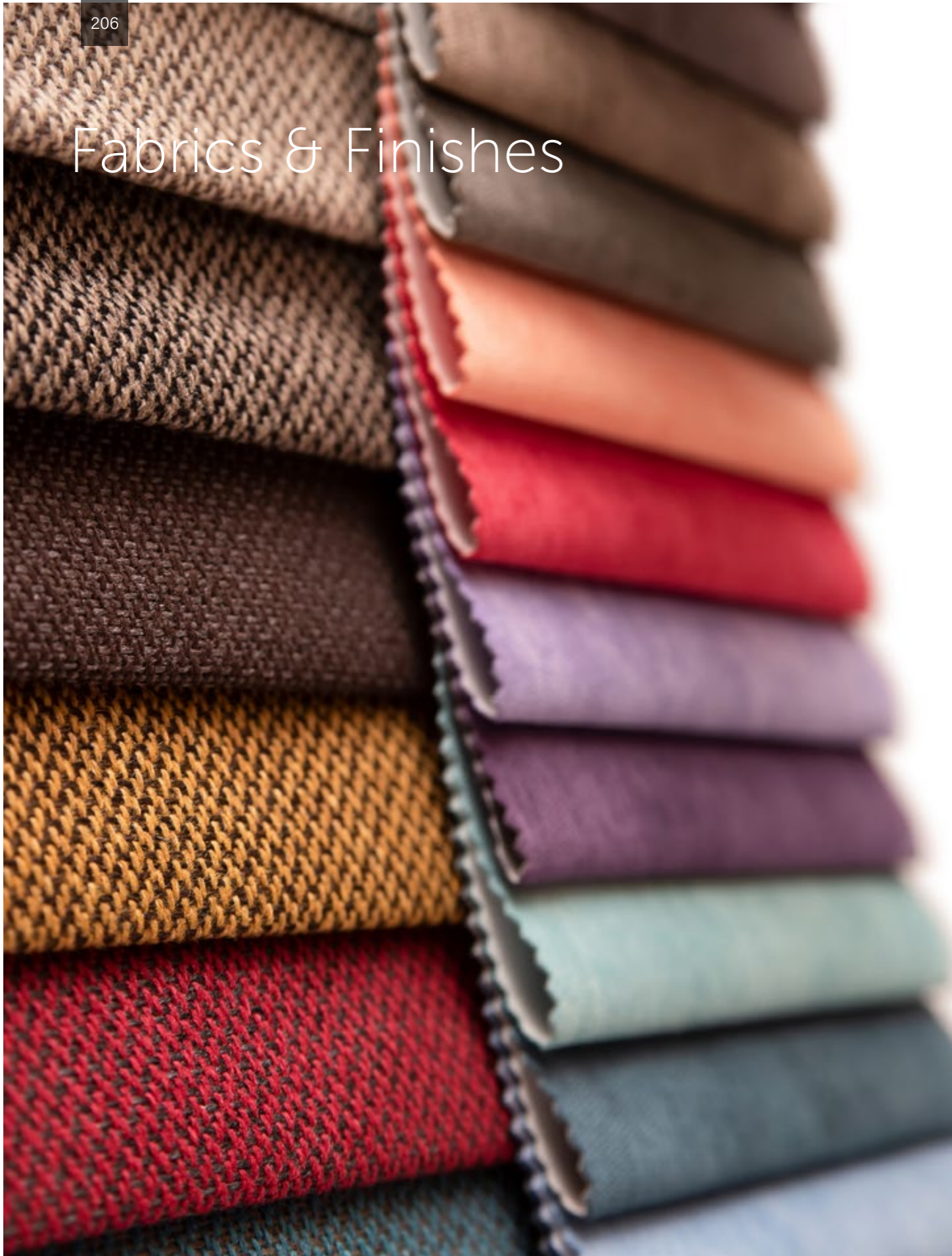
Available with and without Castors



Thales

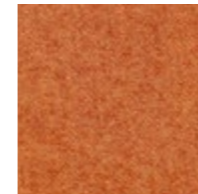


Fabrics & Finishes

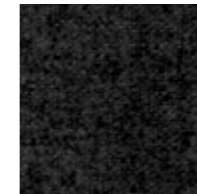


Fabric Shades

SF SERIES



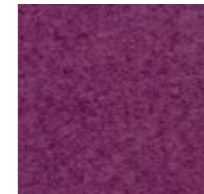
SF-04
Trangerine Orange



SF-05
Raven Black



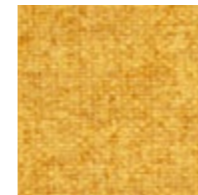
SF-07
Aqua Blue



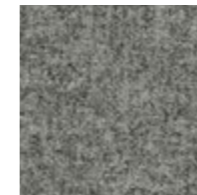
SF-08
Lavender Purple



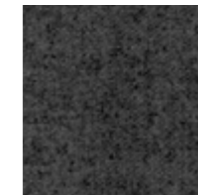
SF-11
Kiwi Green



SF-19
Canary Yellow



SF-21
Ash Grey



SF-25
Stone Grey



SF-30
Ice Blue

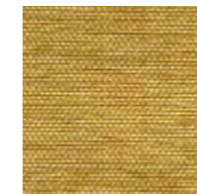


SF-31
Tulip Red

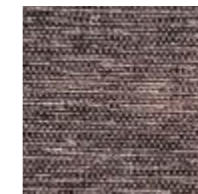
PUNCH SERIES



Punch 53347



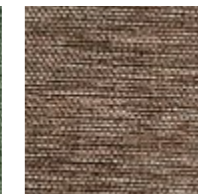
Punch 54012



Punch 58736



Punch 55216



Punch 58705



Punch 54015



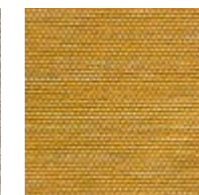
Punch 58633



Punch 52208



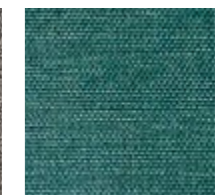
Punch 59138



Punch 54011



Punch 58735



Punch 56133

Leatherette

GRANA VO SERIES



Powder Coating



Laminate



PAN India & International Network



FEATHERLITE PRODUCTS (P) LTD.

16/A, Millers Road, Vasanthnagar, Bangalore - 560 052.

CUSTOMER CARE

080 4719 1010

sales@featherlitefurniture.com

www.featherlitefurniture.com

Present in 66 locations

across India, also in Nepal, Sri Lanka, and U.A.E.



ONLINE STORE



STORE LOCATOR